



USDOT Region V Regional University Transportation Center Final Report

NEXTRANS Project No 071Y03.

Computing Moving and Intermittent Queue Propagation in Highway Work Zones

By

Hani Ramezani

Graduate Research Assistant

Civil and Environmental Engineering

University of Illinois, Urbana-Champaign

hrameza2@illinois.edu

Rahim F. Benekohal

Professor of Civil and Environmental Engineering

University of Illinois, Urbana-Champaign

rbenekoh@uiuc.edu

Final Report

July 2012



DISCLAIMER

Funding for this research was provided by the NEXTRANS Center, Purdue University under Grant No. DTRT07-G-005 of the U.S. Department of Transportation, Research and Innovative Technology Administration (RITA), University Transportation Centers Program. The contents of this report reflect the views of the authors, who are responsible for the facts and the accuracy of the information presented herein. This document is disseminated under the sponsorship of the Department of Transportation, University Transportation Centers Program, in the interest of information exchange. The U.S. Government assumes no liability for the contents or use thereof.



USDOT Region V Regional University Transportation Center Final Report

TECHNICAL SUMMARY

NEXTRANS Project No. 0711Y03

Final Report, July 29, 2012

Computing Moving and Intermittent Queue Propagation in Highway Work Zones

Introduction

Drivers may experience intermittent congestion and moving queue conditions in work zones due to several reasons such as presence of lane closure, roadway geometric changes, higher demand, lower speed, and reduced capacity. The congestion and queue have spatial and temporal effects and knowing their extent is needed in finding users' cost, and in selecting traffic management strategies to reducing congestion in work zones.

The first objective of this study is to develop a computer program, called IntQ, to estimate delay and queue length for intermittent queues in work zones. The IntQ models intermittent arrival pattern for groups of vehicles and generates the group characteristics, such as inter-group gap and group size, from statistical distributions developed from field data for work zones. Then the groups are moved along the network under certain rules. Also the effects of traffic volume on the distributions is discussed.

The second objective is to develop a computer program called MovQ to study moving queues in work zones. Inputs to MovQ are geometric, construction and demand data, and output is queue length, delay, and state of traffic. The MovQ establishes speed-flow curves for each section of a work zone and uses shockwave theory to keep track of interactions between traffic waves.

The report includes discussions about computational issues, input/output data, and example problems that are solved using the programs.

Findings

IntQ uses the following group characteristics to model intermittent arrival patterns.:

- 1-Speed of group leader
- 2-Group size (the number of vehicles in a group)
- 3-Inter-group gap

4-Average headway of followers in a group

Different statistical distributions were fit to the group characteristics data that were collected from three work zones where speed limit was 55 mph, and no work activity or speed reduction treatments were in place. The hourly volumes of the three data sets were 650, 930, and 1310 pcphpl. The results of Chi-square test showed that normal distribution can represent both the speeds of group leaders and the average headway of followers. Furthermore, the shifted negative exponential model was fit to the group size distributions and found that shifted negative exponential, lognormal and weibull could model inter-group gap distributions with a p-value of greater than 0.1. However it is recommended to use shifted negative exponential model for the inter-group gap distribution since it requires fewer parameters to be estimated. When volume is different from the hourly volume of the three data sets, but the other work zone conditions are similar, one can determine the parameters of the distributions by interpolation with respect to traffic volume.

Also, MovQ program establishes speed-flow curves for the following work zones: 1) work zones with speed limit of 55, 2) work zones with speed limit of 45 and no flagger, 3) work zones with speed limit of 45 and flagger. The program has two features that can increase accuracy of the results compared with other methods. 1) MovQ can find capacity using speed-flow curves while HCM 2010 or similar methods find work zone capacity from a regression equation that does not work once flow break-down occurs. Hence the speed-flow curves enable users to find flow rate and operating speed in break-down and stop-and-go conditions. 2) MovQ considers two potential bottleneck locations (i.e. the work space and the transition area), estimates capacity for both the locations, and uses shockwave theory to study how queues and waves interact with each other.

Recommendations

It is recommended to use IntQ to study intermittent queues or when queue length fluctuations within the interval is important. MovQ is also recommended to analyze moving queues in work zones especially when arrival rate is uniform.

The current group characteristics data were collected from work zones with speed limit of 55 mph with no work activity, and no treatments. More Data collection is needed to find distributions of the group characteristics for different work zone conditions.

Contacts

For more information:

Rahim F. Benekohal
Principal Investigator
Civil and Environmental Engineering
University of Illinois, Urbana-Champaign
rbenekoh@uiuc.edu

NEXTRANS Center
Purdue University - Discovery Park
2700 Kent B-100
West Lafayette, IN 47906
nextrans@purdue.edu
(765) 496-9729
(765) 807-3123 Fax
www.purdue.edu/dp/nextrans

ACKNOWLEDGMENTS

The authors would like to acknowledge that some paragraphs describing the input and output of the software are basically taken from another report that the authors wrote with Kivanc Avrenli. We appreciate his indirect contributions to this report.

TABLE OF CONTENTS

Page

LIST OF FIGURES	iv
CHAPTER 1. INTRODUCTION	1
CHAPTER 2. GROUP BASED MESOSCOPIC SIMULATION TO ESTIMATE INTERMITTENT QUEUE LENGTH AND DELAY	4
2.1 Methodology.....	6
2.2 IntQ: Algorithm	7
2.2.1 Module 1- Group Generation.....	7
2.2.2 Module2- Group Motion.....	8
2.3 Statistical Distributions for Group Characteristics	11
2.3.1 Field Data.....	12
2.3.2 Average Headway of Followers.....	12
2.3.3 Group Size	15
2.3.4 Speed.....	17
2.3.5 Inter-group Gap.....	19
2.3.6 Summary.....	22
2.4 IntQ: the compute program.....	23
2.4.1 Work Space Inputs	24
2.4.2 Demand Input.....	29
2.4.3 Output Data from Worksheet “Work Space Input”	30
2.4.4 Output Data from Worksheet “Demand Input”	31
2.4.5 Output Data from Worksheet “Run and Results”	32
2.4.6 Example problem.....	32
CHAPTER 3. MovQ: A COMPUTER PROGRAM TO STUDY MOVING QUEUES .	36
3.1 METHODOLOGY	37
3.1.1 Work Zone Geometry	37
3.1.2 Developing Speed-flow Curves	38
3.1.3 Shockwave Analysis	39
3.2 Computational Issues.....	40
3.2.1 Approximation 1: Creation of a New Wave in The Middle of a Time Step	40
3.2.2 Approximation 2: Two Shockwaves Reach the Same Location at The Middle of Time Step.....	43
3.3 INPUT AND OUTPUT DATA	44
3.3.1 “Work Space Inputs”	45
3.3.2 “Buffer Distance Inputs” And “Two-lane Section Inputs”	49
3.3.3 “Demand Input”	50
3.3.4 Output Data from Worksheet “Work Space Input”	51

3.3.5	Output Data from Worksheets “Buffer Distance Input” and “Two-lane Section Input”	53
3.3.6	Output Data from Worksheet “Demand Input”	53
3.3.7	Output Data from Worksheet “Run and Results”	53
3.4	TUTORIALS	54
3.4.1	Getting Started	54
3.4.2	Example Problems	55
CHAPTER 4. CONCLUSIONS		68
REFERENCES		71
APPENDIX A: STEP-BY-STEP ALGORITHM TO ESTIMATE CAPACITY		A-1

LIST OF FIGURES

Figure	Page
Figure 1-1: Queue Length for A) Intermittent Queue B) Moving Queue.....	1
Figure 2-1: Intermittent Arrival Pattern.....	4
Figure 2-2: Group Size Distribution for I-74.....	6
Figure 2-3: Average Headway of Followers For Different volume Levels: A) Low B) Moderate C)High	15
Figure 2-4: Group Size Distribution For Different Volume Levels: A) Low B) Moderate C) High.....	17
Figure 2-5: Speed Distribution of Group Leaders For Different Volume Levels: A) Low B) Moderate C) High	19
Figure 2-6: Inter-Group Gap Distribution For Different Volume Levels: A) Low B) Moderate C)High	22
Figure 2-7: Work Space and Buffer Distance Lengths.....	26
Figure 3-1: Work Zone Sketches A) According To MUTCD Definition B) Simplified Sketch.....	38
Figure 3-2: Position of The Shockwave SU3bU3aat A) Time t and B) Time $t+\Delta t$	40
Figure 3-3: Traffic Evolution When The Shockwave SU3bU3a is About to Reach The End of The Two-lane Section: A) Time t, B) Time $t+\Delta t_1$, and C) Time $t+\Delta t$	41
Figure 3-4: Entrance of a Shockwave into a New Section in MovQ A) time t B) Time $t+\Delta t$	42
Figure 3-5: Interaction Between Two Shockwave, Moving Toward Each Other A) Time t B)After Reaching the Same Location	44
Figure 3-6: Adjustment in MovQ When Two Shockwave Move Toward Each Other A) Before Adjustment B) After Adjustment.....	44

CHAPTER 1. INTRODUCTION

Drivers may experience intermittent congestion and moving queue conditions in work zones due to several reasons such as presence of lane closure, roadway geometric changes, higher demand, lower speed, and reduced capacity. The congestion and queue have spatial and temporal effects and knowing their extent is needed in finding users' cost, and in selecting traffic management strategies to reducing congestion in work zones.

Queue in the field might be intermittent queue or moving queue. Figure 1-1A and B respectively show queue length variations for intermittent queue and moving queue conditions in the field. In intermittent queue conditions, queue exists for several minutes followed by a non-queueing conditions. The states of queue and non-queue conditions repeated during the analysis period. On the other hand in Figure 1-1B, moving queue conditions occurs for about 25 minutes and then no queue exist in the field and thereafter demand is consistently below capacity.

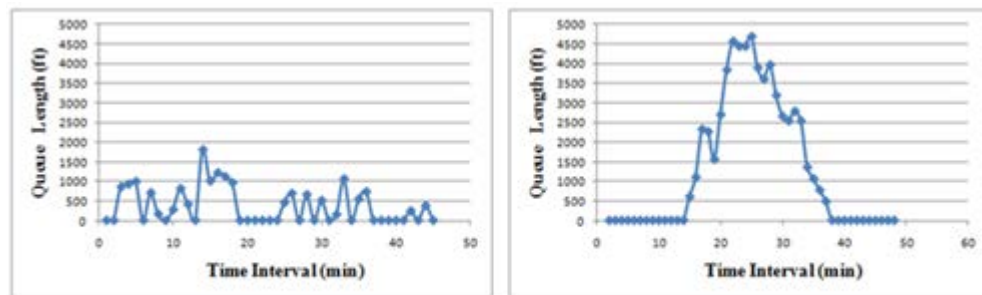

Figure 1-1: Queue Length for A) Intermittent Queue B) Moving Queue

A number of methodologies have been developed to estimate queue length and delay in work zones. Jiang (1999) proposed a model to estimate users' cost including queuing delay cost and vehicle operating cost. Stochastic queuing theory was used for random queues in uncongested conditions while deterministic queuing theory was applied for congested conditions. In another work, Jiang and Adeli (2003) estimated queuing delay by a deterministic queuing model. Chien and Chowdhury (2002) used simulation data to show that the deterministic queuing model underestimates delay. Chitturi et al. (2008) developed a step-by-step methodology to estimate capacity, queue length and delay for stopped queues. In another study, Chitturi and Benekohal (2009) modeled the effects of speed distribution and speed difference between cars and trucks on delay estimation. They also proposed a step-by-step methodology to estimate delay. Furthermore, Ramezani, Benekohal, and Avrenli (2010) proposed a methodology for moving queues as well as for combination of stopped and moving queues. In another study Ramezani, Benekohal, and Avrenli (2011) developed a methodology to estimate delay and length of both intermittent and continuous moving queues. The method for intermittent queues divides traffic into groups and assumes that they have the same characteristics such as size (i.e number of vehicles in a group) and speed.

Although this assumption resulted in a closed-form solution to estimate delay, as will be discussed in Chapter 2, it did not consider randomness in the group characteristics to achieve more reasonable estimates for queue length. Hence there is a need to find a method which models stochasticity in arrival pattern for intermittent queues. Also, the methodology for the continuous moving queues applies shockwave theory to estimate delay and queue length. The model requires dealing with flow-density curves of different sections in a work zone and tracing shockwaves during the analysis period. Doing all these calculations manually, could cause error in results and is time consuming. Thus a computer program is needed to ease the use of the methodology and reduce possible errors in the results.

Hence, the objectives of this study are to:

- 1-develop a computer program which mesoscopically simulates arrival pattern and studies intermittent queues

2-develop a computer program which is able to establish speed-flow curves for different sections of a work zone and apply shockwave theory to estimate delay and queue length for moving queues.

This report is organized into 4 chapters. Chapter 1 is the introduction. Chapter 2 discusses a mesoscopic simulation method for modeling intermittent arrival pattern and how the group characteristics, such as inter-group gap and size, are generated from statistical distributions and how the groups are moved along the network. A computer program, called IntQ, is developed based on the proposed method to automate the calculations and an example problem is solved by IntQ.

Chapter 3 introduces MovQ program to study moving queues. The MovQ divides the work zone into three sections and for each section speed-flow curves are developed using the procedure suggested by Benekohal, Ramezani and Avrenli (2010). Then uses shockwave theory to monitor traffic evolution as discussed by Ramezani, Benekohal and Avrenli (2011). Chapter 3 also provides example problems that are solved by the program. Chapter 4 contains the conclusions and recommendations of the study.

CHAPTER 2. GROUP BASED MESOSCOPIC SIMULATION TO ESTIMATE INTERMITTENT QUEUE LENGTH AND DELAY

The concept of intermittent queue was introduced by Ramezani, Benekohal, and Avrenli (2011). Intermittent queue happens when a moving queue lasts for a short time period (for example several minutes) followed by another short period without the queue presence, and then queuing condition occurs again.

The cause of intermittency could be due to capacity variations, arrival variations or both. Ramezani, Benekohal, and Avrenli (2011) studied intermittent queues when the intermittency is due to variation in arrival pattern while the bottleneck capacity remained constant. To illustrate the intermittent arrival pattern, Figure 2-1 shows the cumulative arrival pattern assuming that vehicles are traveling in separate groups. The whole analysis interval is divided into two sets of subintervals: T_i 's and Y_i 's. T_i represents a subinterval during which group i arrives at the bottleneck. The time gap between arrivals of group i and group $i+1$ is Y_i . The group i arrives the bottleneck in interval T_i , but no vehicle arrives during interval Y_i . This arrival pattern happens cyclically hence cycle i , C_i , is defined as the summation of Y_i and T_i .

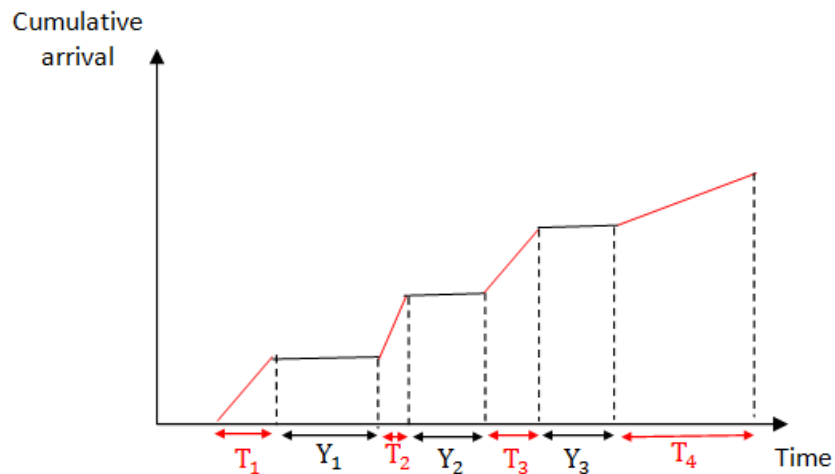

Figure 2-1: Intermittent Arrival Pattern

Formulations were developed to estimate intermittent queue length and delay. In the proposed formulations it was assumed that all the characteristics such as group size and arrival time are the same for all groups and consequently Y_i and T_i have fixed values.

The above mentioned assumption led to a closed-form solution which can be easily computed; however generally vehicle groups do not have the identical characteristics. For example one of the group characteristics is the number of vehicles in a group (i.e. group size). Figure 2-2, shows the distribution of group size for a data set collected from I-74. Group size varies between 1 and 47 with an average value of 5.5 vehicles. Using the average groups size for all the groups will hide stochastic variation in queue length. This will cause underestimation in maximum queue length. In this data set, arrival of 47 vehicles (maximum group size) could create a much longer queue than arrival of 6 vehicles (\approx the average group size). Also, using average group size may mask interaction between the groups. For example in this data set, a group of several vehicles which follows a group of 47 vehicles are more likely to be combined with the lead group and create a longer queue at the bottleneck than when they follow a group of 6 vehicles (\approx average group size) . The issue will be more pronounced when one notices that almost 11% of groups, which includes 38% of traffic volume, are in group sizes greater than 11. This means that overall these vehicles are more likely to experience considerably longer queues than average group size. Hence this chapter establishes a methodology to incorporate stochasticity in arrival pattern and, based on that, it develops a computer program to automate the methodology.

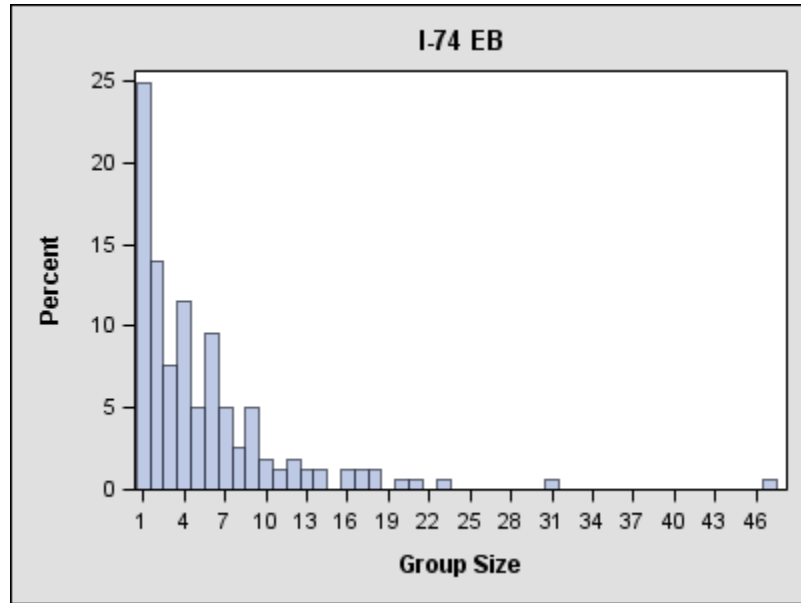

Figure 2-2: Group Size Distribution for I-74

2.1 Methodology

A mesoscopic simulation approach, is proposed to estimate queue length and delay for intermittent queues. Each vehicle group is characterized by randomly generated variables from appropriate distributions. The group characteristics are:

- 1) n_i , the size of group i which is the number of vehicles in group i . The minimum group size is one in which case the group is a single free flowing vehicle. The group size for a platoon of vehicles is two or more.
- 2) \bar{h}_i , average headway of vehicles in group i , excluding the headway of the leader of the group; and is computed using the following equation :

$$\bar{h}_i = \frac{\sum_{j=2}^{n_i} h_j}{n_i - 1} \quad 2-1$$

Where j is the order of the vehicles in group i and n_i is the size of group i . While developing the statistical distribution from field data, \bar{h}_i is not computed for the

groups whose size is one since there are no followers in these groups. However, to estimate the processing time of these groups in the simulation, a random number is generated from the distribution and assigned to them assuming that average headway of followers is enough to process a single free flowing vehicle.

- 3) U_i , speed of the leader of group i . It is assumed that all vehicles in the group i have the same speed and it is equal to U_i .
- 4) Y_i , the time gap between arrivals of groups i and $i+1$. In this report, this variable is called inter-group gap.
- 5) T_i , the time during which group i enters the bottleneck. In this report, T_i will be referred to as “time occupancy” for the group i . ? is it duration of time group I is in the bottleneck?

In the mesoscopic simulation model, it is assumed that these distributions are known. Also it is assumed that readers are familiar with the basic concepts of simulation and in particular they know how to generate a random variable from a distribution.

2.2 IntQ: Algorithm

The simulation has two modules: 1) Group Generation, and 2) Group Motion. In the first module, all the groups that will enter the network within the analysis period are generated. In the second module, the generated groups are moved along the network.

2.2.1 **Module 1- Group Generation**

Assume that the analysis period is denoted by T , the following steps should be taken to generate all the groups:

Step 1.0) Assign $i=1, T_i^{Enter}=0$

i is a counter for the generated groups, and T_i^{Enter} is the time that group i enters the network.

Step 1.1) Generate the following characteristics from corresponding distributions for group i :

Size (n_i), average headway of followers (\bar{h}_i), and speed (U_i)

Step 1.2) Compute time occupancy, T_i , and space occupancy, S_i , as below:

$$T_i = n_i \bar{h}_i \quad 2-2$$

$$S_i = T_i * U_i \quad 2-3$$

Step 1.3) Generate an inter-group gap (Y_i) and determine the time that group (i+1) will enter the network as below:

$$T_{i+1}^{Enter} = T_i^{Enter} + T_i + Y_i \quad 2-4$$

Step 1.4) if $T_{i+1}^{Enter} > T$, then go to Module 2; Otherwise, do $i=i+1$ and go to step 1.1 to generate a new group.

At the end of this module, all the characteristics of the groups and their arrival time are known.

2.2.2 Module2- Group Motion

Step 2.0) Initialization

Determine time step (Δt) and analysis period (T), and assign $t=0$, $i=1$.

The analysis period, T , should be the same as the one used in the Step 1.4 of the module 1. The variable t is to keep track of time and i is a counter for the groups which enter the network.

Step 2.1) Check the group entrance

If $t \leq T_i^{Enter} < t + \Delta t$ then group i enters the network.

Step 2.2) Moving the groups along the network

Beginning from the downstream of the network, update the position of the front boundary, X_{fi} , and rear boundary, X_{ri} , of the group i as below:

$$X_{fi} = \begin{cases} 0 & \text{if the group } i \text{ entered the network in the current time step} \\ X_{fi} + \Delta t \times U_i & \text{Otherwise} \end{cases} \quad 2-5$$

$$X_{ri} = X_{fi} - S_i \quad 2-6$$

Front boundary of a group is the front bumper of the group leader and the rear boundary of a group is the rear bumper of the last vehicle in the group.

Step 2.3) Group-following condition

If $X_{r(i-1)} - X_{fi} < \text{Const1}$ then

$$U_i = U_{i-1} \quad 2-7$$

$$\bar{h}_i = \bar{h}_{i-1} \quad 2-8$$

And update time occupancy and space occupancy using Equations 2-2 and 2-3.

This condition checks the space gap between two consecutive groups. If it is less than a threshold, Const1, then the leader of group i , behind the group $(i-1)$, is no longer free flowing vehicle, and it is following the leader of group $(i-1)$. Example of this condition is when vehicles move behind a slow-moving truck. In this case, any group which moves faster than the truck and becomes close to the truck group has to slow down, join the group, and follow the truck.

Previous studies (Benekohal, Ramezani, and Avrenli 2010, Ramezani, Benekohal, and Avrenli 2010) used space headway of 250 ft as a threshold to detect followers. However in the IntQ, space gap is used instead of space headway, and the space gap corresponding to the space headway of 250 is around 200 ft . Thus a threshold of 200 ft is recommended for Const1.

Step 2.4) Check downstream condition

This step verifies if a group is close enough to a particular factor affecting traffic conditions at the downstream location. If it is close, then assume that the group is affected by the factor. Examples of the downstream factors are the posted speed limit, having an on-ramp, presence of flagger, and work activity in the work zone. In this simulation, the factors are present at fixed locations implying that the bottleneck has a fixed location. For instance, drivers reduce their speed due to presence of a flagger in work space (at a fixed location in the work zone).

If the location of the beginning and end of the bottleneck are denoted by X_{bb} and X_{eb} , respectively then

If $X_{bb} - X_{fi} < \text{const2}$. then

$$\begin{cases} \bar{h}_i = \bar{h}_{cap} & \text{if } \bar{h}_i < \bar{h}_{cap} \\ \text{Do not change } \bar{h}_i & \text{Otherwise} \end{cases} \quad 2-9$$

Where, \bar{h}_{cap} is 3600/capacity (vphpl).

Also update U_i by reading the speed, corresponding to the flow of $3600/\bar{h}_i$ from the speed-flow curve of the bottleneck.

It is recommended to use 200 ft for both Const2 and Const1 since, as discussed for Const1 in the Step 2.3, it is a threshold under which vehicles are assumed to be influenced by downstream conditions.

This step checks when vehicles are close to the work space, their speed and headways are updated according to the speed-flow curve of the work space.

Step 2.5) Travel time estimation

It is assumed that the travel time for the group leader represents the travel time for all the other vehicles in the group as they move at the same speed. Thus If $X_{fi} > X_{eb}$ then assume that the leader passed the bottleneck and estimate the travel time, TT_i , for each vehicle in the group i as below:

$$TT_i = t - T_i^{Enter} \quad 2-10$$

Step 2.6) Going to the next time step

$$t = t + \Delta t \quad 2-11$$

If $t > T$ then stop; Otherwise go to Step 2.1.

2.3 Statistical Distributions for Group Characteristics

The IntQ requires four random variables which should be generated for each group. The variables are: group size, average headway of followers in a group, inter-group gap, and speed of group leaders.

Sadeghosseini and Benekohal (1995) investigated the headway distribution on freeways and effects of traffic volume on the parameters of headway distribution and percent of in-platoon vehicles. Sun and Benekohal (2005) suggested shifted negative exponential distribution for platoon size and Weibull distribution for time gap distribution using work zone data. Ramezani, Benekohal, and Avrenli (2010) fit shifted negative exponential distribution for both platoon size and inter-platoon gap and suggested normal distribution for average headway of followers in work zones.

The previous works did not study all four random variables (e.g. speed distribution of group leaders) needed for the IntQ. Also effects of traffic volume on the distribution of these four random variables have not been addressed. This section will find statistical distributions for these four random variables using field data for different traffic volumes. The rest of this section discusses the field data and distributions that represent the data.

2.3.1 Field Data

Field data includes 3 data sets which belong to work zones with speed limit of 55 mph, no work activity, and no treatments. All the work zones were 2-to-1 work zones where one of the two lanes is open in a given direction.

Table 2-1 displays information about the data sets. The data sets are named as “Low”, “Moderate”, and “High” indicating volume levels of the data sets. Volume ranges from 648 to 1307 pcphpl and average speed varies between 45.4 mph to 54.5 mph. Also, percent of free flowing vehicles which can be taken as an indication of congestion is between 18% and 49%. Hence the data cover from a low volume condition to close-to-capacity conditions.

Table 2-1: Traffic information of the data sets

Name	Site	Hourly volume (vphpl)	Percent of heavy vehicles	Hourly volume (pcphpl)	Percent of free flowing vehicles	Average speed	Duration (min)
Low	I-80, WB	540	40	648	49	54.5	45
Mod	I74, EB	817	28	931	34	53.6	41
High	I74, EB	1269	6	1307	18	45.4	44

2.3.2 Average Headway of Followers

Consistent with the previous studies (Benekohal, Ramezani, and Avrenli 2010, Ramezani, Benekohal, and Avrenli 2011), followers are defined as the vehicles which have either a time headway of less than 4 seconds or a spacing of less than 250 ft. Average headway of followers is not computed for single free flowing vehicles since these single-vehicle groups do not have any followers. However when the group size is

more than one, average headway is computed for the followers (i.e. all vehicles excluding the group leader).

Average headway of flowers in a given group is computed and treated as a single observation. Descriptive statistics are shown in Table 2-2A for the three data sets. The number of observations is between 92 and 130 thus the sample size is not low to find statistical distribution of the data. The highest observations are less than 4 seconds since in these data sets all the followers had a headway of less than 4 seconds which comes from the criteria to detect followers. Also mean of the observations decreases as volume increases.

Table 2-2: Average headway of followers: A) descriptive statistics B) fitted distribution

Part a			
Data set	High	Moderate	Low
Number of observations	118	130	92
Lowest observation	0.80	0.5	0.93
Highest observation	3.87	3.77	3.87
Mean	1.95	2.08	2.27
Standard deviation	0.56	0.57	0.64
Part b			
Data set	High	Moderate	Low
Location parameter (Mu)	1.95	2.08	2.27
Scale parameter (Sigma)	0.56	0.57	0.64
P-value	0.26	0.79	0.53

Table 2-3: Probability density functions

Distribution	Equation	Parameters		
		Location	Scale	Shape
Shifted Negative Exponential	$p(x) = \begin{cases} \frac{1}{\sigma} \exp\left(-\frac{x-\theta}{\sigma}\right) & x \geq \theta \\ 0 & x < \theta \end{cases}$	θ	σ	-
Lognormal	$p(x) = \begin{cases} \frac{1}{\sigma\sqrt{2\pi}(x-\theta)} \exp\left(-\frac{(\log(x-\theta)-\xi)^2}{2\sigma^2}\right) & x > \theta \\ 0 & x \leq \theta \end{cases}$	θ	ξ	σ
Weibull	$p(x) = \begin{cases} \frac{c}{\sigma} \left(\frac{x-\theta_0}{\sigma}\right)^{c-1} \exp\left(-\left(\frac{x-\theta_0}{\sigma}\right)^c\right) & x > \theta_0 \\ 0 & x \leq \theta_0 \end{cases}$	θ_0	σ	c
Normal	$p(x) = \frac{1}{\sigma\sqrt{2\pi}} \exp\left(-\frac{(x-\mu)^2}{2\sigma^2}\right) \quad -\infty < x < \infty$	μ	σ	-

Figure 2-3 demonstrates the distribution of the data. Each bin width is 0.3 seconds and the midpoint of each bin is shown on the horizontal axis. The distributions are bell-shaped and this is expected from the Central Limit Theorem which illustrates that the distribution of the average of a random variable is close to the normal distribution. Chi-square test was used to evaluate the goodness of fit for the normal distribution, introduced in Table 2-3. The parameters were estimated by Maximum Likelihood Method and the estimated mean (μ) and standard deviations (σ) are the same as those for the field data, shown in Table 2-2B. P-values in Table 2-2B for all the distributions are greater than 0.1, meaning that the normal distributions are not significantly different from the empirical distributions at 90 percent confidence level or higher. Average headway varies between 1.95 and 2.27 second and standard deviation ranges from 0.56 to 0.64 seconds. Both the average and standard deviation of the distributions decrease at higher volume; the reason for this trend might be due the fact that overall when traffic volume increases, headway between vehicles, including headway of followers, decreases.

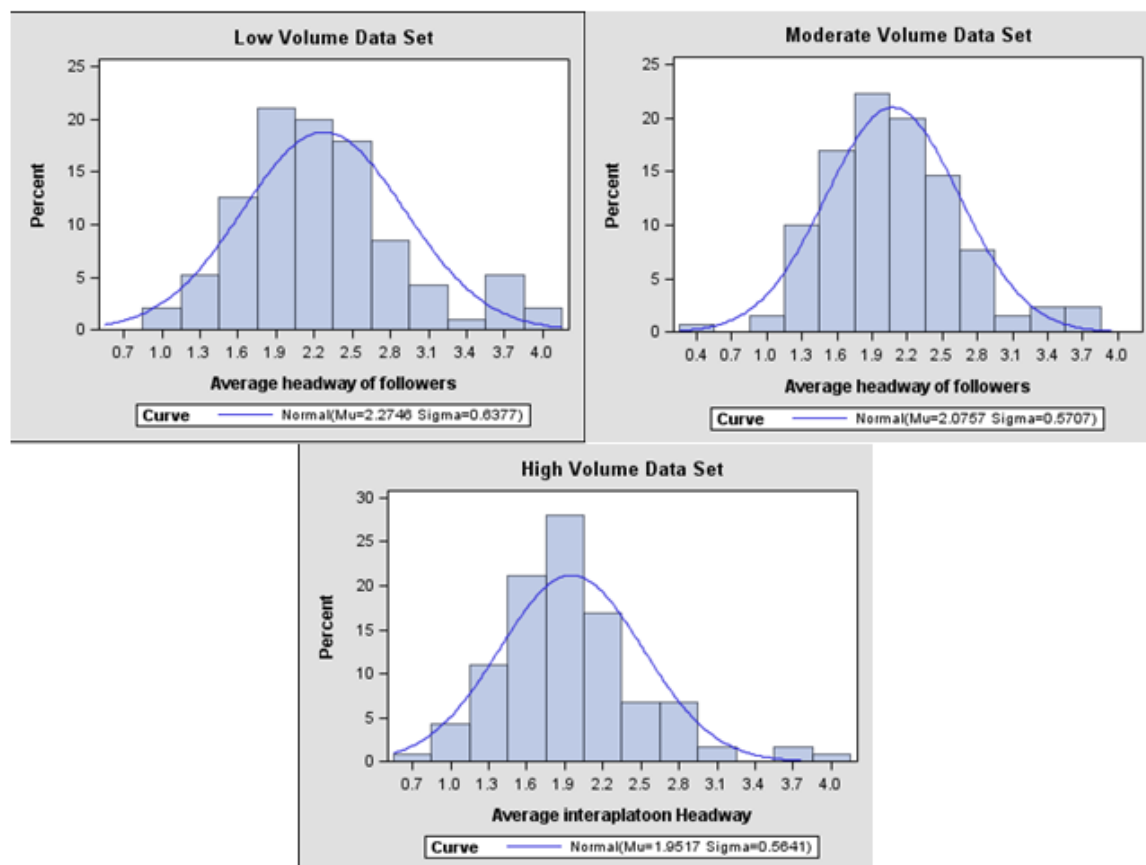

Figure 2-3: Average Headway of Followers For Different volume Levels: A) Low B) Moderate C) High

2.3.3 Group Size

Group size is the number of vehicles in a group. It is one for a single free flowing vehicle and more for a platoon of vehicles. Descriptive statistics of the data are displayed in Table 2-4A. Average varies between 2.1 and 5.5, and standard deviation ranges from 1.7 to 6.1. As expected, both average and standard deviation increase as volume increases. The reason might be that in higher volume chance of observing large platoons becomes higher so it is expected to have a higher mean in higher traffic volumes. The trend for the standard deviations can be justified when one notices that in higher volume the range of data is larger and it is more likely to have higher standard deviations.

Table 2-4: Group size: A) descriptive statistics B) fitted distributions

Part a				
Data set		High	Moderate	Low
Number of observations		157	201	185
Mean		5.5	2.8	2.1
Lowest observation		1	1	1
Highest observation		47	10	9
Standard deviation		6.1	2.1	1.7
Part b				
Data set		High	Moderate	Low
Lognormal Distribution	Location parameter (Theta)	0.49	0.49	0.49
	Shape parameter (Sigma)	1.18	0.93	0.83
	Scale parameter (Zeta)	1	0.41	0.06
	P-value	0.03	0.09	0.03
Exponential Distribution	Location parameter (Theta)	0.49	0.49	0.49
	Scale Parameter (Sigma)	5.03	2.27	1.53
	P-value	0.18	0.35	0.43
Weibull Distribution	Location parameter (Theta)	0.49	0.49	0.49
	Shape parameter (C)	0.93	1.16	1.19
	Scale parameter (Sigma)	4.84	2.4	1.63
	P-value	0.24	0.08	0.02

Figure 2-4, demonstrates the distribution of group size for the three volume levels. Each bin represents a particular group size, and it starts from 1, for single free flowing vehicles. The observed distributions are skewed to right thus the goodness of fit are examined for three distributions that are right-skewed and shifted. The distributions are: lognormal, negative exponential and weibull. The parameters of the distributions are introduced in Table 2-3. The magnitude of the location parameter for all the distributions should be slightly less than the beginning of the first bin, hence it was set to be 0.49 which is less than the beginning of the first bin, 0.5. The other parameters of the models were computed by Maximum Likelihood Method and shown in Table 2-4B. Based on this table, the shifted negative exponential distributions are not different from the observed distributions as their P-values are greater than 0.1 (see Table 2-4B).

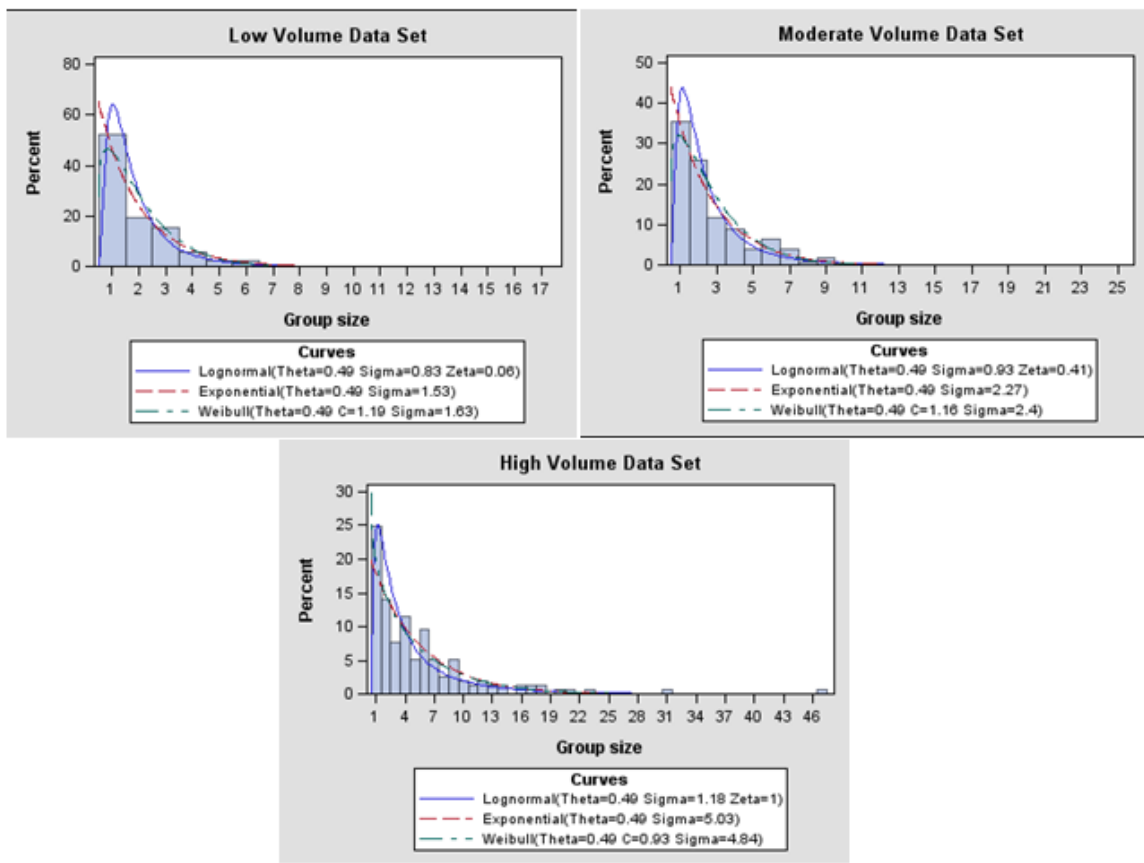

Figure 2-4: Group Size Distribution For Different Volume Levels: A) Low B) Moderate C) High

2.3.4 Speed

Table 2-5, shows the descriptive statistics for leaders' speed. Ranges of the data are roughly between 31 mph and 36 mph. Also, mean speed for the low and the moderate volume data sets are close to posted speed limit, 55 mph, however it is almost 5 mph less than the posted speed limit for the high volume data set. These mean values convey this hypothesis that at moderate and low volumes, speed of free flowing vehicles is not sensitive to traffic volume while it is sensitive at high volume levels. To examine the hypothesis more data set is needed. Besides, standard deviation increases as volume increases.

Table 2-5: Speed of leaders: A) descriptive statistics B) fitted distributions

Part a			
Data set	High	Moderate	Low
Number of observations	157	201	199
Lowest observation	36.4	41.1	40.9
Highest observation	67.2	77.19	74.0
Range	30.8	36.09	33.1
Mean	49.8	55.2	54.6
Standard deviation	6.0	5.5	4.7
Part b			
Data set	High	Moderate	Low
Location parameter (Mu)	49.8	55.2	54.6
Scale parameter (Sigma)	6.0	5.5	4.7
P-value	0.63	0.12	0.94

The histograms of the data are displayed in Figure 2-5. The observed distributions are almost bell-shaped and imply that normal distribution might be enough to model the observed distribution. The parameters, estimated by Maximum Likelihood Method, and p-values, for Chi-square goodness of fit test, were displayed in Table 2-5B. All the p-values are greater than 0.1 which means that it cannot be claimed that the estimated and the observed distributions are statistically different. The lowest p-value belongs to the data set with moderate volume and the main reason is that there is a big discrepancy between the observed and the fitted distributions for the bin with midpoint of 58. This discrepancy caused a p-value which is considerably less than that of the other data sets; however since it is less than 0.1, the fitted distribution can be accepted.

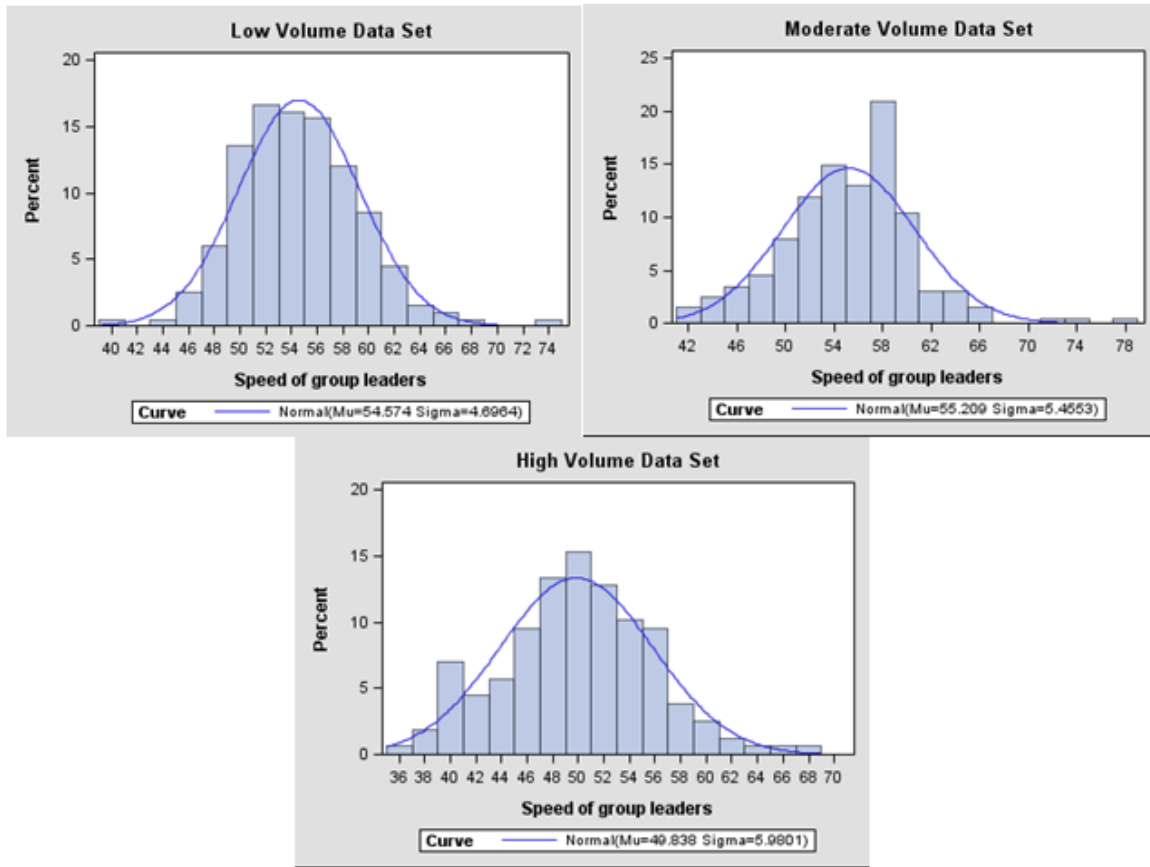

Figure 2-5: Speed Distribution of Group Leaders For Different Volume Levels: A) Low B) Moderate C) High

2.3.5 Inter-group Gap

To compute inter-group gaps, it is needed to find group leaders since their time gaps are equal to inter-group gaps. According to Benekohal, Ramezani, and Avrenli (2010), group leaders (i.e. free flowing vehicles) are the vehicles which have a headway, more than or equal to 4 seconds or a spacing which is more than or equal to 250 ft. After detecting these vehicles using the two criteria above, inter-group gaps are computed as below:

$$G_{inter} = h_{GL} - K \frac{L_{pre}}{v_{pre}} \quad 2-12$$

where

G_{inter} =Inter-group gap (sec),

h_{GL} =Headway (sec) of a group leader,

K =Conversion factor from mph to ft/sec (1.47),

v_{pre} =Speed (mph) of the preceding vehicle,

L_{pre} =Length (ft) of the preceding vehicle. The length was determined to be 7 ft for motorcycles, 14 ft for passenger cars, 32 ft for large single unit trucks, and 64 ft for semi trailers. Details on finding the average length of each vehicle type can be found in (Ramezani, Benekohal, and Avrenli 2010).

Table 2-6A reports the descriptive statistics for the three data sets. Number of observations is equal to the number of groups for each data set. Also, it is expected that the lowest observation to be less than 4 seconds since in Equation 2-12, the lowest value for h_{GL} , headway of a group leader, is 4 seconds. The highest observations are between 24.8 sec and 44.2 sec and it decreases as volume increases. Mean and standard deviation of the inter-group gaps respectively ranges from 6.8 sec. to 11.0 sec. and from 3.3 sec to 7.7 sec, and both decrease as traffic volume increases. This is expected as volume increases, overall, time gap between vehicles becomes shorter and it is more likely to have lower standard deviations.

Table 2-6: Inter-group gap: A) descriptive statistics B) fitted distributions

Part a				
Data set		High	Moderate	Low
Number of observations		157	201	199
Lowest observation		3.04	3.25	3.22
Highest observation		24.8	38.0	44.2
Mean		6.8	9.9	11.0
Standard deviation		3.3	6.5	7.7
Part b				
Data set		High	Moderate	Low
Lognormal Distribution	Location parameter (Theta)	2.99	2.99	2.99
	Shape parameter (Sigma)	0.89	1.02	1.06
	Scale parameter (Zeta)	0.99	1.48	1.6
	P-value	0.68	0.56	0.92
Exponential Distribution	Location parameter (Theta)	2.99	2.99	2.99
	Scale Parameter (Sigma)	3.79	6.88	7.96
	P-value	0.14	0.98	0.65
Weibull Distribution	Location parameter (Theta)	2.99	2.99	2.99
	Shape parameter (C)	1.27	1.12	1.08
	Scale parameter (Sigma)	4.1	7.18	8.22
	P-value	0.4	0.96	0.75

As displayed in Figure 2-6, the observed inter-group distributions are skewed to the right. Similar to the group size data, the shifted-exponential, the shifted-lognormal, and the shifted weibull distributions are examined for their goodness of fit. The equations and the definitions of the parameters for these distributions were presented in Table 2-3. The location parameter should be less than the lowest observation. Hence the lowest observation (see Table 2-6A) was rounded down and a value, slightly less than the rounded value was chosen for the location parameter which is 2.99 sec. The other parameters, determined by Maximum Likelihood Method, as well as p-values for the chi-square goodness-of-fitness test are shown in Table 2-6B. All the p-value are more than 0.1 hence all the distributions are not statistically different from the observed one.

According to Table 2-6B, all the location parameters are the same as it was set up for all the distributions. The other parameters, except the shape parameter for Weibull distributions, decrease as volume increases. This relationship is inverse for the shape parameter of the Weibull distributions.

Because of two reasons the exponential distribution is recommended. First, using exponential distribution for inter-group gap is according to the common notion which considers exponential distributions for independent arrival pattern. Group arrival can be considered to be independent arrival since it is assumed that the arrival of the group leader which is a free flowing vehicle, is not influenced by downstream conditions. Second, compared with the other distributions, the exponential distribution is simpler and requires lower number of parameters to be estimated. Hence it seems that at this stage exponential distribution can be preferred over the other distributions however final decision is deferred until more data sets from different work zone conditions are explored.

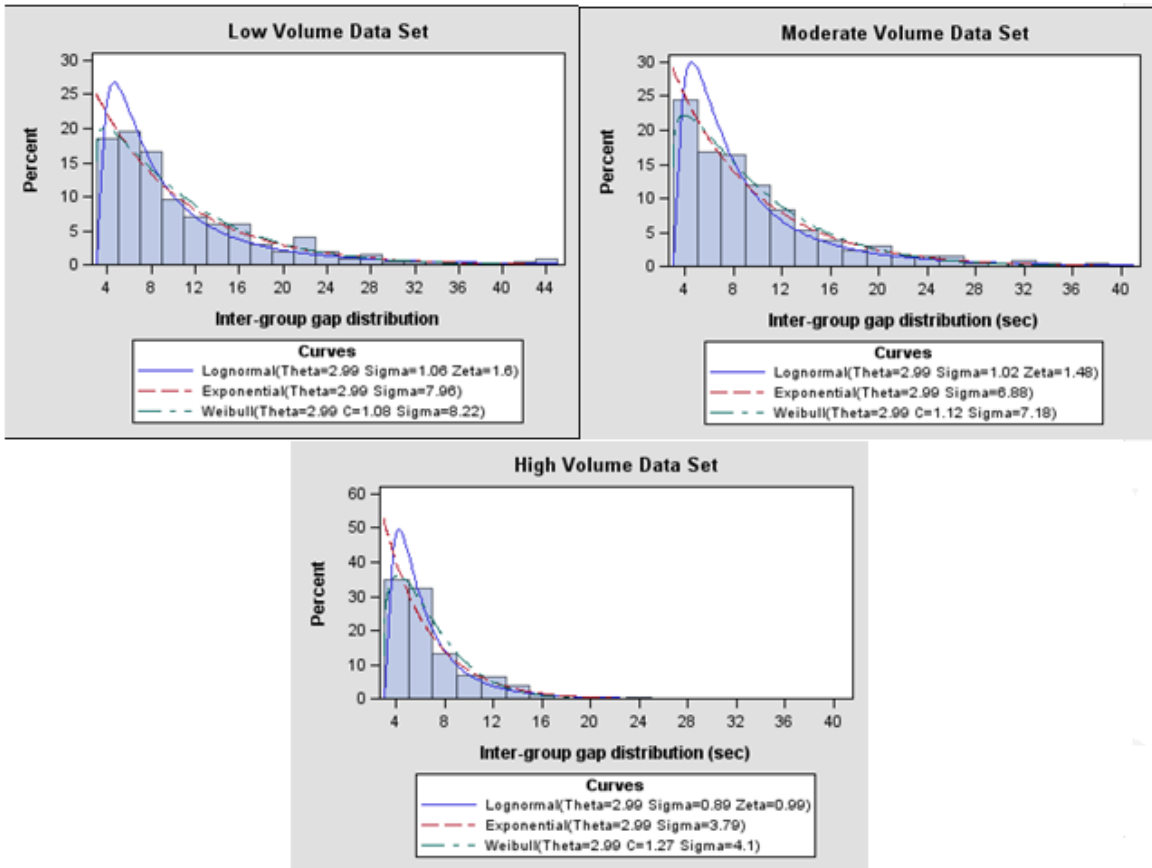

Figure 2-6: Inter-Group Gap Distribution For Different Volume Levels: A) Low B) Moderate C)High

2.3.6 Summary

Empirical distributions of the group characteristics were extracted from field data, collected for three work zones with speed limit of 55 mph, no treatments, no work activity and different volume levels, ranging from 650 pcphpl, to 1310 pcphpl. Preliminary data analysis showed that observed distributions for both group size, and inter-group gap are skewed to right while they are bell-shaped for the two distributions of average headway of followers in a group, and leaders' speed. The goodness of fit of the normal distribution was tested for the bell-shaped distributions and that of lognormal,

negative exponential, and weibull distributions was evaluated for the right-skewed distributions.

Based on the Chi-square goodness of fit test, the followings were considered not to be different from the field data ($p\text{-value} > 0.1$ for all the three data sets):

- 1) normal distribution for the average headway of followers in a group (find the parameters in Table 2-2B),
- 2) negative exponential distribution for group size, (find the parameters in Table 2-4B)
- 3) normal distribution for leaders' speed (find the parameters in Table 2-5B), and
- 4) three distributions of negative exponential, lognormal, and Weibull for inter-group gap (find the parameters in Table 2-6B).

The parameters of these distributions can be found in Tables 2-2B through 2-6B. One can use these distributions to generate group characteristics for the corresponding work zone. For a work zone with similar conditions (i.e. speed limit of 55 mph, no work activity and no treatments) and different volume level one can find the parameter of the distributions by interpolating with respect to hourly volume in pchpl. It is recommended to collect data and fit distributions to work zones with work activity, treatments.

2.4 *IntQ: the compute program*

IntQ was developed assuming that users are familiar with the fundamentals of traffic flow theory. IntQ algorithm was implemented in VBA to automate the calculations and the program includes three worksheets:

1-Work Space Input

2-Demand Input

3-Run and Results

Work Space Input worksheet estimates capacity based on the work space geometry and conditions. Appendix A illustrates the step-by-step procedure, developed by Benekohal et al. (2010), to estimate capacity and its speed.

In Demand Input worksheet, traffic volumes are entered to estimate the parameters of group characteristics distributions. Based on the field data analysis in Section 2.3, normal distributions are considered for the average headway of followers and speed of group leaders and the program applies shifted negative exponential distributions for intergroup gaps and groups sizes. How to estimate the parameters of the distributions was explained in Section 2.3.6.

Users can run the program in the Run and Results worksheet. The program is based on the IntQ algorithm proposed in Section 2.2.

Input and output data in each worksheet are explained as below.

2.4.1 Work Space Inputs

2.4.1.1 Inputs For Step Zero

Time Interval for Arrival Volume (Cell B16): The interval length (min) for which arrival volume is available is entered in cell B16. There are four options available: 5, 15, 30, and 60 min. The interval length should be selected based on the availability of the arrival data. If there are flexibilities in selecting the time interval, it is recommended to use 15-min interval for continuous queue and 5 min interval for intermittent queues. The definitions of these types of queue were brought in Chapter 2. Since the program reports the state of traffic at the end of each time interval, users can more accurately track evolution of traffic if a short interval is selected. Using 30-min and 60-min interval may mask some of the evolutions such as a queuing condition which lasts for 20 minute. Five-min interval is recommended for intermittent queues since usually these queues last for several minutes and using any interval longer than 5 minutes may not show formation of intermittent queue . However when continuous queue is in the work zone, 15-min interval is expected to be adequate as these types of queue are expected to be longer than 15-min.

Time Step (Cell C16): The interval length to update the calculation is entered in cell C16. Five options are available for each interval length which is entered in cell B16. Table 3-1, shows the available options for each value determined in cell B16. When arrival data are given for a long interval, a very high level accuracy is not usually expected. Thus very short time steps that most likely are not interesting in these situations are not available and instead users can choose larger ones. For example when 1-hr arrival data are used, the shortest time step is 1 sec. rather than 0.1 sec.

Table 3-7: Available time steps for different intervals for which arrival rates are given

		Interval length (min) for arrival volume			
		5	15	30	60
Options for time step (sec)	Option 1	0.1	0.5	0.5	1
	Option 2	1	5	10	15
	Option 3	15	30	30	30
	Option 4	30	60	60	60
	Option 5	60	120	120	120

As discussed in the Section 3.3.1, the time step should be selected considering the length of the sections. If the shortest section is 0.5 miles, the time step should be at least close to 10 sec. For other lengths of the shortest section, the recommended time step should be determined proportionally.

Simulation Seed (Cell D16): Simulation seed should be a positive and integer value. The program will consider the integer part of the entered value if it is not integer. Moreover, if the seed is not positive number the program automatically assign 5000 to the seed.

Number of Runs (Cell E16): The number of runs should be more than 2 to avoid error in computing the sample standard deviations. If the value of the Cell E16 is less than 2, the program runs the simulation for 2 times. Also when the entered number is a

non-integer value, the program considers the integer part of it. One may determine the number of runs by establishing the confidence interval for the MOEs, reported in the results. In this case, both mean and standard deviation of the MOEs are provided in the results to establish the confidence interval and estimate the number of runs.

2.4.1.2 Geometric Inputs for Step 1

Work Space Length (Cell B20): Length of the Work Space in feet is entered in the cell B20. Figure 2-7 demonstrates a work zone where one of the two lanes is closed, and traffic moves from left to right. According to MUTCD, work space is the “portion of the roadway closed to traffic and set aside for workers, equipment, and material.”

Buffer Distance Length (Cell C20): Length of the Buffer Distance (see Figure 2-7) in feet is entered in the cell C20. It is measured from the beginning of the transition taper to the beginning of the work space.

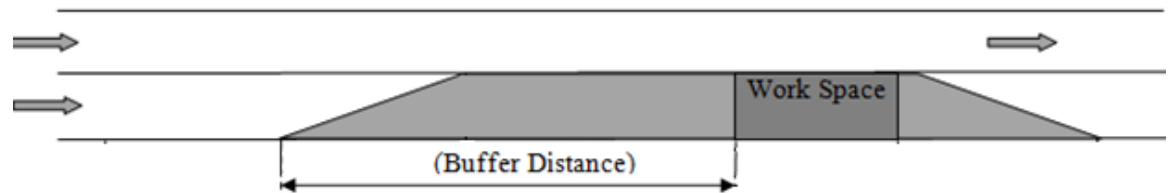

Figure 2-7: Work Space and Buffer Distance Lengths

Lane Width (Cell D20): The input for the cell D20 is the lane width in feet. According to HCM 2010, it is defined as “the arithmetic mean of the lane widths of a roadway in one direction, expressed in feet”. The default value is 12 ft. The lane width must be between 8 ft. and 16 ft.

Left Shoulder Width (Cell E20): The input for cell E20 is the left shoulder width in feet from the left edge of the travel lane to the median. The default value is 2 ft., and the left shoulder width must be less than or equal to 16 ft.

Right Shoulder Width (Cell F20): The input for cell F20 is the right shoulder width in feet from the right edge of the travel lane to the edge of the traffic control devices (TCD). The traffic control devices can be cones, concrete barriers, etc... The default value is 6 ft., and the right shoulder width must be less than or equal to 16 ft.

2.4.1.3 Work Zone Condition Inputs for Steps 2-6

This part of the worksheet starts from the column D and ends with the column K. Each row of the columns belongs to a particular interval of analysis. The beginning and end of the intervals and corresponding input data are introduced as below:

Start Time (Column B): Column B shows the start time of a particular interval in question. When the interval length for analysis is specified by the user, the start times shown in column B are updated automatically by the workbook. Users are not allowed to modify the cells in column B.

End Time (Column C): Column C shows the end time of a particular interval in question. When the interval length for analysis is specified by the user, the end times shown in column C are updated automatically. Users are not allowed to modify the cells in column C.

Specifying Time Intervals to be Analyzed (Column D): Each cell in column D has a dropdown list that returns either “N” or “Y”. By using the dropdown lists, users specify the time periods to be analyzed. The default entry for column D is “N”. For all time periods to be analyzed, users should select “Y” from the dropdown lists of the corresponding cells in column D. For instance, the interval length is 60 min, and the user wants to analyze the time period from 2:00 PM to 3:00 PM. Then the user should select “Y” from the dropdown list of the cell in column D that is in the same row as the desired time period.

In Steps 2-6, input data into Column D should be entered in the first place. Otherwise, if users do not specify the time periods to be analyzed, the workbook does not display the input cells in columns E through K.

Presence of Work Activity (Column E): Each cell in column E has a dropdown list that returns either “N” or “W”. By using the dropdown lists, users select the time period during which the crew will be working. The default entry for column E is “N”, which assumes no work activity. For all time periods with work activity, users should select “W” from the dropdown lists of the corresponding cells in column E.

Presence of Flagger (Column F): Each cell in column F has a dropdown list that returns either “N” or “F”. By using the dropdown lists, users select the time periods

during which a flagger will be present in the work zone. The default entry for column F is “N”, which assumes no flagger. For all time periods with flagger, users should select “F” from the dropdown lists of the corresponding cells in column F.

Speed Limit (Column G): The input in column G is the work zone speed limit. Each cell in column G has a dropdown list that returns either “45” or “55”. By using the dropdown lists, users specify the work zone speed limit in mph for the time periods to be analyzed. The default entry for column G is “55”, which assumes a speed limit of 55 mph. If the speed limit for a particular interval is 45 mph, users should select “45” from the dropdown list of the corresponding cell in column G.

Work Zone Type (Column H): The input for column H is the work zone type. Each cell in column H has a dropdown list that returns either “S” or “L”. Column H requires input data only for the time periods with work activity. By using the dropdown lists, users specify whether the work zone is short-term or long-term for the time periods to be analyzed. The default entry for column H is “L”, which assumes long-term work zone. If a short-term work zone is analyzed in a particular interval, users should select “S” from the dropdown list of the corresponding cell in column H. For the time periods with no work activity, users are not allowed to enter input data in column H. Short-term work zones are those where the work space is generally separated from the traffic by means of easily portable devices such as like cones and barrels. On the other hand, concrete barriers are usually utilized to separate the traffic from the work space in long-term work zones.

Work Intensity (Column I): The input for column H is the work intensity. Each cell in column I has a dropdown list that returns either “L”, “M”, or “H”. Similar to column H, column I also requires input data only for the time periods with work activity. By using the dropdown lists, users specify the level of work intensity for the time periods to be analyzed. The default entry for column I is “M”, which assumes “moderate” work intensity. If there is “high” work intensity in a particular time period, users should select “H” from the dropdown list of the corresponding cell in column I. Likewise, if there is “low” work intensity in a particular time period, users should select “L” from the

dropdown list of the corresponding cell in column I. For the time periods with no work activity, users are not allowed to enter input data in column I.

Users can refer to Appendix 1 of this report for the detailed definition of “low”, “moderate”, and “high” work intensity.

Speed Reduction due to Treatment (Column J): Sometimes, there may be an additional speed reduction treatment in the work zone such as police presence, speed photo enforcement, changeable message signs, etc... If there is an additional speed reduction treatment in the work zone during a particular time period, users enter the estimated speed reduction due to the treatment in the corresponding cell of column J. The estimated mean speed reductions due to various treatments can be taken from Table A-6. If there is no additional speed reduction treatment, column J should be left blank.

Speed Reduction due to Other Factors (Column K): If there are other speed-reducing factors not considered so far, users enter the estimated speed reduction due to those factors in column K. Such factors can be inclement weather conditions, temporarily reduced lane/ shoulder width, etc... If there are no such other factors, column K should be left blank.

2.4.2 Demand Input

Arriving volumes and traffic composition are determined in this worksheet.

PCE (Cell B17): The input for cell B17 is the passenger car equivalent (PCE), which is defined in HCM 2010 as the “the number of passenger cars that are displaced by a single heavy vehicle of a particular type under prevailing roadway, traffic, and control conditions”. HCM 2010- suggests a PCE of 1.5 for level terrain, 2.5 for rolling terrain, and 4.5 for mountainous terrain for basic freeway sections. The cell B17 has a dropdown list that returns either 1.5, 2.5, or 4.5. The default value is 1.5. If the PCE is computed for a specific condition and differs from the values given in the dropdown list, users are allowed to enter the computed value in cell B17. The maximum allowable entry is 7.0 as suggested by the HCM 2010. On the other hand, the minimum allowable entry is 1.0.

Start Time (Column B): Column B is the same as column B of the worksheet “Work Space Input”. Users are not allowed to modify these cells.

End Time (Column C): Column C is the same as column B of the worksheet “Work space Input”. Users are not allowed to modify these cells.

Expected Hourly Traffic Demand (Column D): The input for column D is the hourly traffic demand, measured in the two-lane section in vehicles per hour (vph).

Percentage of Single-Unit Trucks (Column E): The input for column E is the percentage of single-unit trucks. The default value is 5%. Single-unit trucks have more than four tires touching the pavement, so the percentage of single-unit trucks excludes vans and pickup trucks.

Percentage of Multiple-Unit Trucks (Column F): The input for column F is the percentage of multiple-unit trucks. The default value is 5%. According to AASHTO 2001, multiple-unit (combination) trucks consist of “a single-unit truck with a full trailer, a truck tractor with a semitrailer, or a truck tractor with a semitrailer and one or more full trailers”.

2.4.3 Output Data from Worksheet “Work Space Input”

Some of the outputs are placed in the input sheets to let users immediately observe the effect of inputs on the related outputs. Then users are able to find some of the inputs that cause unreasonable results. As explained in the color coding section, the title cells of the outputs has a Navy Blue background with white text. This section involves in-depth explanation of the outputs that each worksheet returns. The output data described in the following subsections are obtained only if users enter the required input data properly.

2.4.3.1 Outputs From Step 1

Speed Reduction due to Lane Width (Cell G20): The output in cell G20 is the estimated speed reduction in mph due to lane width. It is computed based on Table A-1.

Speed Reduction due to Left Shoulder Width (Cell H20): The output in cell H20 is the estimated speed reduction in mph due to left shoulder width. It is computed based on Table A-1.

Speed Reduction due to Right Shoulder Width (Cell I20): The output in cell H20 is the estimated speed reduction in mph due to right shoulder width. It is computed based on Table A-1.

2.4.3.2 Outputs From Step2-6

In the second part of the worksheet, users obtain the output data from four columns. Each row corresponds to a particular interval for analysis. The workbook returns no outputs for the intervals that are not selected for analysis. The four output columns are described as follows:

Free-Flow Speed (Column L): The output in column L is the free-flow speed in mph. The free-flow speed is computed without considering the speed-reducing effects such as shorter-than-ideal lane width, work intensity, etc... If the work zone speed limit is 55 mph, column L returns a free-flow speed of 62 mph. If the work zone speed limit is 45 mph and there is no flagger, column L returns a free-flow speed of 55 mph. If the work zone speed limit is 45 mph and there is flagger, column L returns a free-flow speed of 43 mph.

Speed Reduction due to Work Intensity (Column M): The output in column M is the estimated speed reduction in mph due to work intensity. It is computed based on Table A-4 for short-term work zones and Table A-5 for long-term work zones.

Adjusted Free-Flow Speed (Column N): The output in column N is the adjusted free-flow speed in mph. The adjusted free-flow speed is computed based on Equation 1A. the adjusted free-flow speed is computed by considering the speed-reducing effects of work intensity, less-than-ideal lane/ shoulder width, additional speed reduction treatments (if they exist), etc...

Maximum Flow Rate (Column O): The output in column O is the estimated maximum flow rate in passenger cars per hour per lane (pcphpl) that can be maintained in the work zone under the prevailing conditions. The maximum flow rate is computed based on the four-regime speed-flow curves given in Figures 3-1A to 3-3A.

2.4.4 Output Data from Worksheet “Demand Input”

This worksheet involves two output columns that are described as follows:

Heavy Vehicle Adjustment Factor (Column G): The output in column G is the heavy vehicle adjustment factor. It is computed based on Equation 3A.

Adjusted Demand (Column H): The output in column H is the adjusted demand in passenger cars per hour per lane (pcphpl). It is computed based on Equation 6A.

2.4.5 **Output Data from Worksheet “Run and Results”**

Results are reported in columns D to K . The outputs are explained as below:

Average Queue Length (Column D and E): for a single time interval, average queue length is estimated as the summation of queue lengths at the end of each time step divided by the number of time steps. Mean and standard deviation of the MOE (Measure of Effectiveness) are computed over the replications and respectively reported in Columns D and E. It is assumed that the beginning of the queue is located at the beginning of the Work Space.

Exit Flow (Column F and G): Mean and standard deviations for the number of vehicles exit the network during each interval are presented in Columns F and G, respectively.

Average Speed (Column H and I): Average speed for each analysis interval, is estimated as the length of the network divided by the average travel time for all the vehicles that exit the network during the interval. Mean and standard deviation of the MOE for all replications are computed in Columns H and I, respectively.

Delay (Column J and K): Total delay is computed based the difference between the actual travel time and travel time under the speed limit for all vehicles in the analysis interval. Its mean and standard deviation can be found in Columns J and K, respectively.

2.4.6 **Example problem**

Average queue length and total delay are computed for a work zone with 11-foot lane width and 1-foot left and right shoulder. The length of the workspace and buffer distance are 2500 ft and 4000 ft, respectively. A Flagger shows “Slow Down” paddle from 4:45 PM to 5:15 PM and moderate work activity exists in the work space with speed limit of 45 mph. Also the work zone is short term since it is separated from the travel lane

using barrels. The Work zone is analyzed for two 15-min intervals where hourly volume of each interval is 700 vph including 2% single unit truck and 8% multiple unit truck. It is intended to run the program for 5 times with time steps of 5 seconds to estimate delay and queue length.

Solution:

Step zero

The length of the interval (15 min) is determined in Cell B16. A 5-sec time step is selected from Cell C16 and 400 is input in Cell D16 as the simulation seed. The number of replications is 5 as entered in Cell E16.

Step 1

Work space length (2500ft), lane width (11ft) and left and right shoulder widths (1ft) are entered in Cells B20 to F20. The following figure shows the inputs for the Steps zero and 1.

14	Input for Step 0				
15		Select the interval length (min) for which arrival volume is given	Select the interval length (seconds) to update the calculations	Determine a seed to generate random numbers	Determine the number of runs
16		15	5	400.0	5.0
17					
18	Input for Step 1 for Work Space				
19		Enter the work space length (ft)	Enter the buffer distance length (ft)	Enter the lane width (ft)	Enter the left shoulder width (ft)
20		2500.0	4000.0	11.0	1.0

Step 2-6

Rows 91 and 92 are corresponding to the first and second intervals, respectively. “Y” is selected in cells D91 and D92 as these two intervals are analyzed. There is work activity in the work zone thus “W” is entered in Column E. Also, Flagger is in the work

zone so “F” is chosen for Column F. Speed limit is 45 mph (Column G) and the work zone is short term with moderate work intensity hence “S” and “M” are entered in Columns H and I, respectively and the other input columns are left blank as shown below.

	Start of Time Interval	End of Time Interval	Put "Y" for the intervals to be analyzed. (Column D)	Put "W" for the intervals when crew is working. (Column E)	Put "F" for the intervals when flagger is present. (Column F)	Put "45" for the intervals if the speed limit is not 55 mph. (Column G)	If crew is working, put "S" for short-term work zones, and put "L" for long-term work zones. (Column H)	If the crew is working, put "L" for low work intensity, put "M" for moderate work intensity, and put "H" for high work intensity. (Column I)	If there is any additional speed reduction (mph) due to treatments/ TCD given in Table 6 of the report, enter that speed reduction. Otherwise, leave it blank. (Column J)	If there is any additional speed reduction (mph) due to any other factors not considered so far, enter that speed reduction. Otherwise, leave it blank. (Column K)
23										
91	4:45 PM	5:00 PM	Y	W	F	45.0	S	M		
92	5:00 PM	5:15 PM	Y	W	F	45.0	S	M		

Demand Input

The work zone is on the level terrain so PCE value of 1.5 is entered in Cell B17. Volume of 700 vph and the truck percentages (2% for single unit and 8% for multiple unit trucks) are input in rows 89 and 90 (see the following figure).

	Start of Time Interval	End of Time Interval	Enter the expected hourly traffic demand during the interval (vph) (Column D)	Enter the percentage of single-unit trucks (%) (Column E)	Enter the percentage of multiple-unit trucks (%) (Column F)
21					
22	12:00 AM	12:15 AM			
89	4:45 PM	5:00 PM	700	2.0%	8.0%
90	5:00 PM	5:15 PM	700	2.0%	8.0%

Click the button in “Run and Results” worksheet to get the results as below:

	A	B	C	D	E	F	G
1							
2	Click to run and get the results						
3							
4				Avg Queue Length (ft) Within the Interval		Exti Flow (vphpl)	
5				Mean	Standard Deviation	Mean	Standard Deviation
6		4:45 PM	5:00 PM	167.63	26.61	134.40	3.65
7		5:00 PM	5:15 PM	225.50	34.29	133.40	1.52

	A	B	C	H	I	J	K
1	<div style="border: 1px solid black; padding: 5px; display: inline-block;"> Click to run and get the results </div>						
2							
3							
4							
5			Avg Speed (mph) Within the Interval		Delay (veh-hr)		
			Mean	Standard Deviation	Mean	Standard Deviation	
6	4:45 PM	5:00 PM	26.35	17.84	2.93	0.09	
7	5:00 PM	5:15 PM	26.59	18.08	2.96	0.12	

CHAPTER 3. MovQ: A COMPUTER PROGRAM TO STUDY MOVING QUEUES

Previous studies assumed that there is only a single location that can be the bottleneck in a work zone (Chitturi and Benekohal 2008 and Jiang 1999), however there are two potential locations for bottlenecks: the work space and/or the transition area. In the work space drivers may reduce their speeds due to several reasons such as presence of workers, equipment near traveled lane, or flaggers. The reduction in speed may cause a reduction in capacity and may create a bottleneck. In the transition area, presence of taper for lane closure or lane shifting may make the drivers to slow down to change lane or merge, and in turn it could reduce the capacity of the road at that point (causing bottleneck). Ramezani and Benekohal (2011) used shockwave theory to analyze congestion in work zones considering the possibility of having two bottleneck locations. Queue propagation and dissipation was analyzed under 6 traffic volume conditions and 5 initial queue conditions. The traffic volume conditions represent the relation between demand and capacities of the bottlenecks while the initial queue conditions describe the location of the front and back of queue in the work zone. Analyses showed that 14 cases (i.e. combinations of traffic volume and initial queue conditions) may cause a queue propagation. The transition area is the only bottleneck location in 4 cases, and the work space is in four other cases. Thus, totally in 8 cases there is just one bottleneck in the work zone. However, in the remaining 6 cases, both the transition area and the work space are the bottleneck locations during the analysis interval. Formulations were developed to estimate queue length and delay using shockwave theory.

Analyzing queuing conditions using the shockwave theory may need high computational effort since sometimes it requires keeping track of several shockwaves in a work zone. Moreover, dealing with all the cases, discussed above, and speed-flow curves of different sections of a work zone adds to computational complexity and increases the possibility of error. Hence, MovQ is developed to make the analyses easier. The computational logic behind the MovQ program is explained in Methodology Section.

Then input and output data in the program are illustrated and finally examples are solved using the software.

3.1 METHODOLOGY

In MovQ, a work zone is divided into several sections and speed-flow curves are developed for each section using the step-by-step procedure proposed by Benekohal, Ramezani, and Benekohal (2010). Then traffic conditions in work zones are updated using shockwave theory as discussed by Ramezani and Benekohal (2011). The rest of this section provides more detail on the methodology.

3.1.1 Work Zone Geometry

According to MUTCD, a typical work zone can be divided into 4 areas as displayed in Figure 3-1A.: 1) the Advance Warning Area 2) the Transition Area 3) the Activity Area, and 4) the Termination Area. The Activity Area is further divided into the Work Space and the Buffer Distance. For the analyses in this report, the work zone sketch is simplified as shown in Figure 3-1B in which it is assumed that lane drop happens at once at the beginning of the taper. Hence the following three sections are considered in the analyses:

- 1) Section 1: the Work Space
- 2) Section 2: the Buffer Distance which starts at the beginning of the transition tapers and ends at the beginning of the Work Space. Hence the Buffer Distance includes the Buffer Space and the Transition Area.
- 3) Section 3: the Two-lane Section which can be measured from the beginning of the first sign in the Advanced Warning Area till the beginning of the transition taper. Section 6C.04 of the MUTCD provides guidance on the placement of the first sign. According to Guidance 5 of this section, “since rural highways are normally characterized by higher speeds, the effective placement of the first warning sign in feet should be from 8 to 12 times the speed limit in mph.”

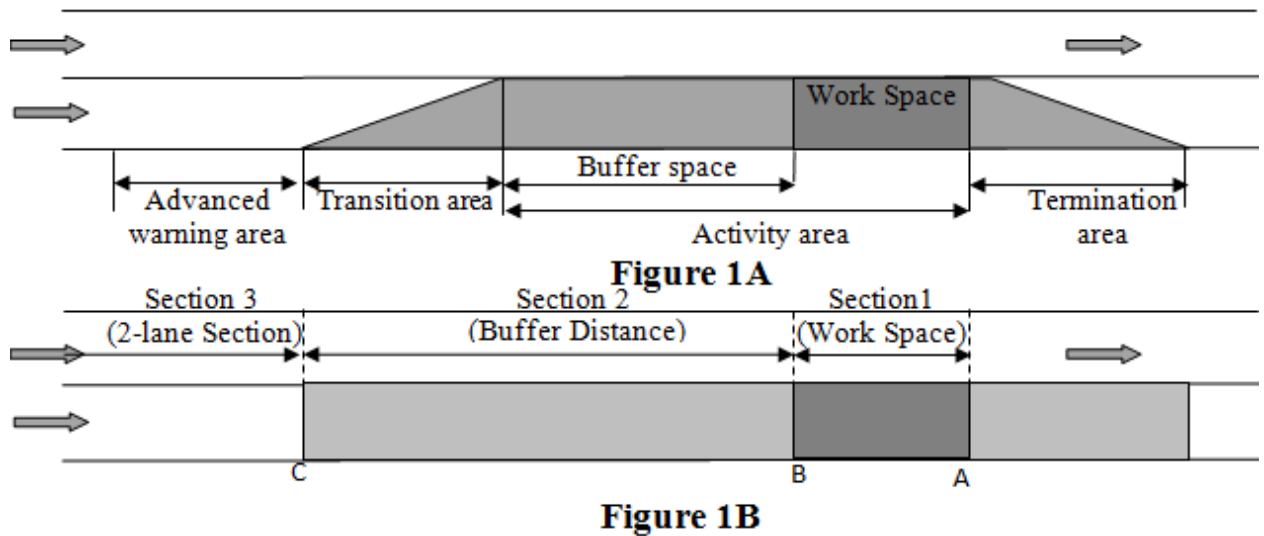

Figure 3-1: Work Zone Sketches A) According To MUTCD Definition B) Simplified Sketch

3.1.2 Developing Speed-flow Curves

Speed-flow curves are established using the step-by-step procedure, developed by Benekohal, Ramezani and Avrenli. (2010). The details of the procedure are explained in Appendix 1. Overall, the procedure requires geometric and construction data to return a speed-flow curve for the Work Space. Similar to speed-flow curves for basic freeway section in HCM 2010, the procedure uses the input data to find speed reductions due to several factors such as non-ideal lane width and lateral clearance, and presence of workers. The speed reductions are applied to a base free flow speed, and then a speed flow curve is established.

Although the procedure was particularly developed for the work space, the computer program modifies the procedure to find speed-flow curves for the other two sections: the Buffer Distance and Two-lane Section, as well. The modified procedure does not take into account several work activity-related factors for the Buffer Distance, and the Two-lane Section since work activity should not happen at these places. Hence users cannot enter the following 4 input data in the computer program for these sections:

- 1) Presence of work activity,

- 2) Presence of flagger,
- 3) Type of work zone (short term or long term), and
- 4) Work intensity level

Since the procedure returns speed-flow curves for a one-lane section, another modification is needed for the Two-lane Section. Based on the input data, provided for the Two-lane Section, the MovQ program finds a speed-flow curve for one lane and it is assumed that both open lanes have the same speed-flow curve. Consequently it is assumed that the capacity of the Two-lane section is twice the capacity of one lane section.

3.1.3 Shockwave Analysis

The methodology divides a work zone into three sections, and each section is further divided into several parts. In each part traffic state may be different. Depending on the traffic conditions, the length of these parts may change over time. The boundary between two adjacent traffic states (i.e. parts) indicates a shockwave. The methodology updates the location of the shockwaves (i.e. boundaries) at the end of each time step. For example Figure 3-2A, shows the traffic states in a work zone at time t . The Two-lane Section was divided into two parts for States U_{3a} and U_{3b} and the shockwave between States U_{3a} and U_{3b} is shown by $S_{U_{3b}U_{3a}}$ which moves forward. The other boundaries in the example are stationary. If speed of $S_{U_{3b}U_{3a}}$ is denoted by V_S , then the boundary between the traffic states of U_{3a} and U_{3b} moves $V_S * \Delta t$ in the direction of traffic after one time step, Δt (See Figure 3-2B). If there were more moving shockwaves in the work zone, similarly the location of shockwaves would be updated based on their speed and the time step.

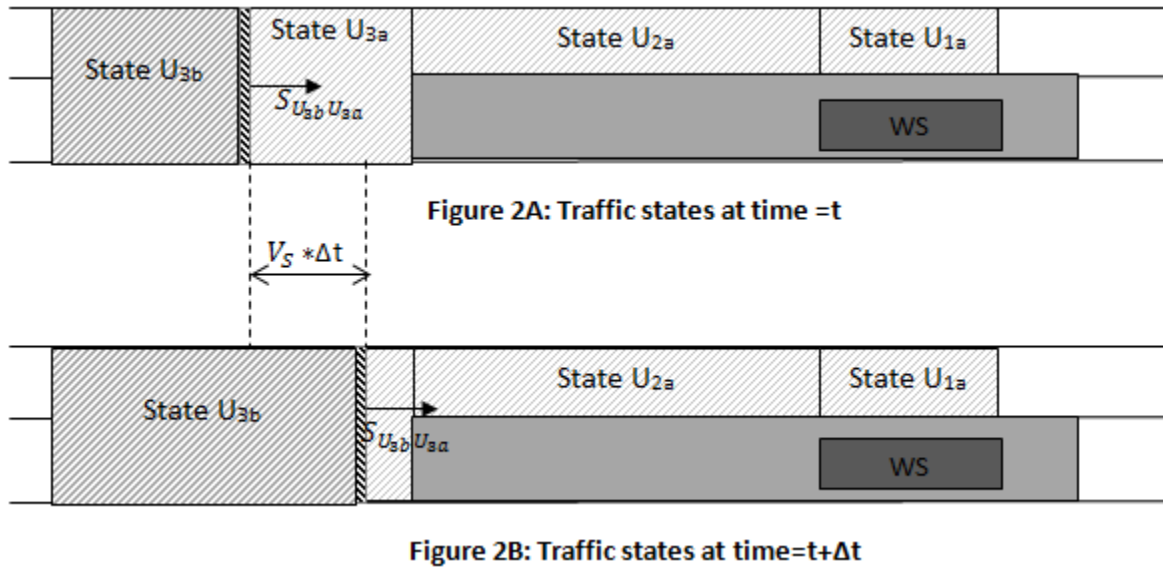

Figure 3-2: Position of The Shockwave $S_{U_{3b}U_{3a}}$ at A) Time t and B) Time $t+\Delta t$

3.2 Computational Issues

The MovQ keeps track of events at the end of each time step thus approximations may be involved in calculations when an event happens in the middle of a time step. As will be discussed later, effects of the approximations are reduced if short time steps are selected. The followings explain the two cases for which approximations were applied.

3.2.1 **Approximation 1: Creation of a New Wave in The Middle of a Time Step**

Figure 3-3A, shows the state of traffic at time t and there is a forward shockwave $S_{U_{3b}U_{3a}}$ in the Two-lane Section. Theoretically, the shockwave reaches the end of the section (See Figure 3-3B) after Δt_1 seconds from the beginning of the time step Δt ($>\Delta t_1$). At time $(t+\Delta t_1)$ a stationary shockwave happens at the location of the lane drop and a new wave, U_{2b} , is created in the Buffer Distance. Then the resulting shockwave $S_{U_{2b}U_{2a}}$ moves forward for Δt_2 sec as displayed in Figure 3-3C. Two new events happened in the middle of the time step: 1) Diminishing State U_{3a} 2) propagation of State U_{2b} ; However the program updates the calculations and detects these events at the end of the time step instead of the middle of the time step. Thus there are some approximations in the simulation.

The MovQ detects this situation by comparing the location of each shockwave with the section to which it belongs. For example, the program computes the location of $S_{U_{3b}U_{3a}}$ at time $t+\Delta t$ as the product of its speed and the time step (Δt). Then the program finds the location of the shockwave somewhere in the Section 2 as shown in Figure 3-4B. This shockwave should not enter the Section2 since traffic states U_{3a} and U_{3b} and the corresponding shockwave belong to the speed-flow curve for the Section 3.

In such a situation, the program assumes that shockwave $S_{U_{3b}U_{3a}}$ reaches the location of the lane drop at the end of the time step, instead of the middle of the time step. Consequently this causes Δt_2 seconds delay in creation of wave U_{2b} and underestimation in movement of shockwave $S_{U_{2b}U_{2a}}$ in the section 2.

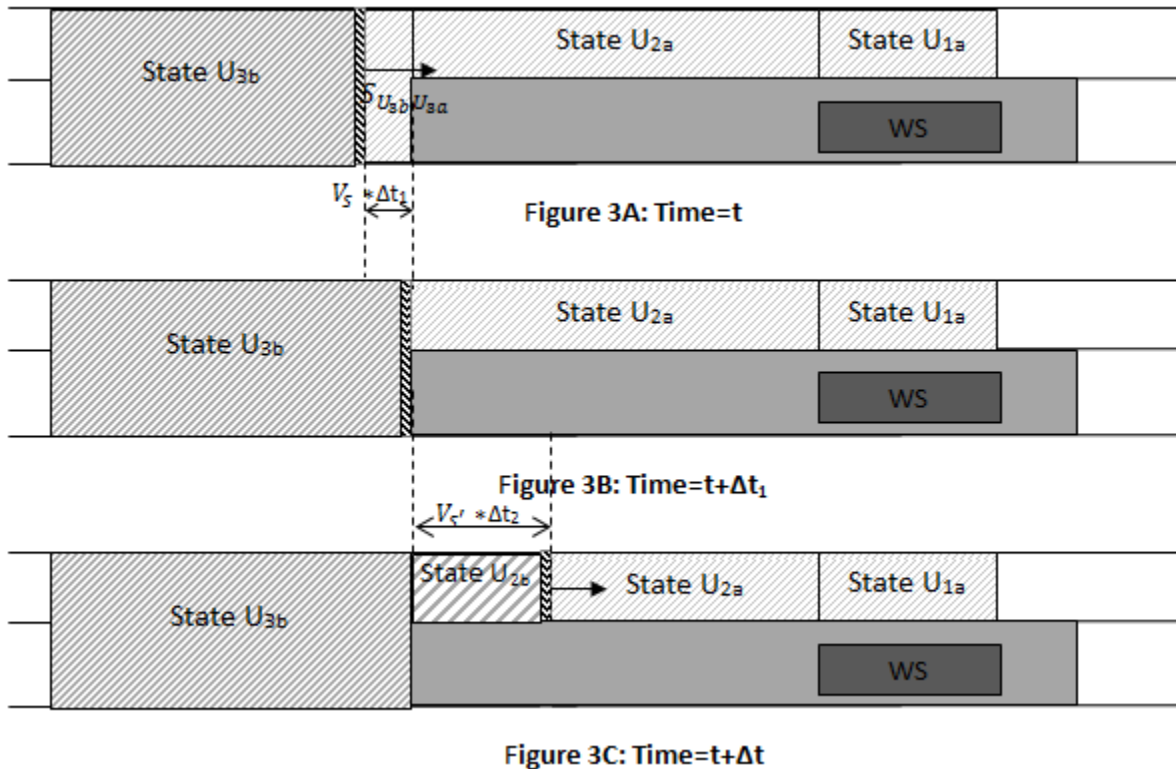

Figure 3-3: Traffic Evolution When The Shockwave $S_{U_{3b}U_{3a}}$ is About to Reach The End of The Two-lane Section: A) Time t , B) Time $t+\Delta t_1$, and C) Time $t+\Delta t$

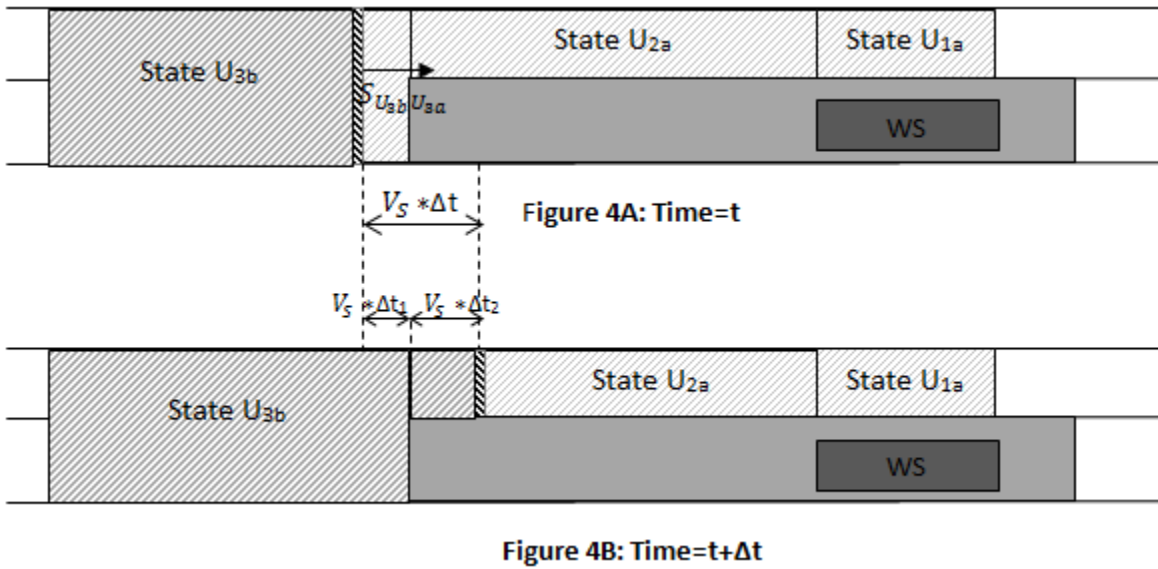

Figure 3-4: Entrance of a Shockwave into a New Section in MovQ A) time t B) Time t+Δt

The delay in creation of the new shockwave, $S_{U_{2b}U_{2a}}$, is Δt_2 hence the magnitude of underestimation in its movement is $V'_S * \Delta t_2$, where V'_S is the shockwave speed. It is tried to estimate an upper bound for the error due the underestimation. The maximum shockwave speed in theory cannot be more than the maximum speed of a wave; hence one can take the maximum speed which is allowed (or observed) in a work zone as an upper bound for the shockwave speed. The speed of 65 mph (=95.3 ft/sec) is used for error calculations. This speed is close to the maximum free flow speed, 62mph, used in the speed-flow curves of the program. Also, Δt is an upper bound for Δt_2 . Hence the underestimation in the shockwave movement is $95.3\Delta t$. Several options, ranging from 0.1 seconds to 2 min, are available for the time step. For the time step of 2 min the maximum error is roughly 2.1 miles while if the time step of 0.1 second is used the maximum error will be 9.5 ft which is less than a car length.

Very short time step may cause high computational effort without any significant improvement in results while long time steps may cause too much approximation. Depending on the accuracy needed, one may select one of the available options for the

time step. However it is recommended to consider the length of the sections on the selection of time steps as well. The length of a section should not be less than the maximum underestimation of a shockwave movement; Otherwise it implies that some shockwaves can travel a section within less than a time step. However to reasonably trace the interaction between the waves, a shockwave should travel a section at least in several time steps. Thus it is suggested to use 10 seconds when the shortest section is 0.5 miles since it takes roughly 3 time steps for the fastest shockwave (65 mph) and more time steps for the other shockwaves to travel within the section. For the other shortest lengths, one can proportionally compute the appropriate time step .

3.2.2 Approximation 2: Two Shockwaves Reach the Same Location at The Middle of Time Step

In Figure 3-5A, two shockwaves $S_{U_{2b}U_{2a}}$ and $S_{U_{2a}Q_{2a}}$ move toward each other. The shockwaves reach the same location in the middle of the time step and thereafter there is only one shockwave, $S_{U_{2b}Q_{2a}}$, separating the State Q_{2a} from the State U_{2b} (see Figure 3-5B). Similar to Approximation 1, the program detects these evolutions at the end of the time step. In such a situation, when the computer program updates the location of the shockwaves, the results show that the two shockwaves passed each other, as shown in Figure 3-6A, while it should not happen. Then the program knows that these shockwaves reached the same location in the middle of the time step. In these conditions MovQ assumes that the two shockwaves meet each other in the middle of distance d at the end of the time step and then the new shockwave $S_{U_{2b}Q_{2a}}$ is created (see Figure 3-6B). Hence in this case, the maximum delay in creation of shockwave $S_{U_{2b}Q_{2a}}$ is Δt and the corresponding underestimation in its movement in the Section 2 is $V_S * \Delta t$ where Δt is the time step and V_S is the shockwave speed. As discussed for Approximation 1, the maximum error in the travel distance of the new shockwave would be close to 2 miles if time step is 2 min and it is close to 10 ft for the time step of 0.1 sec. It is recommended to choose a time step close to 10 seconds when the shortest section of the work zones is

0.5 mile long and for the other length the recommended time step can be estimated proportionally.

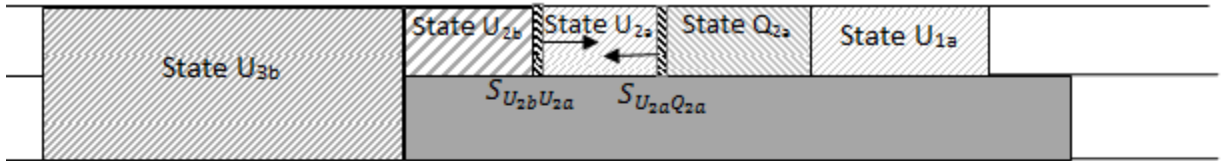

Figure 5A: Two shockwave move toward each other at time t

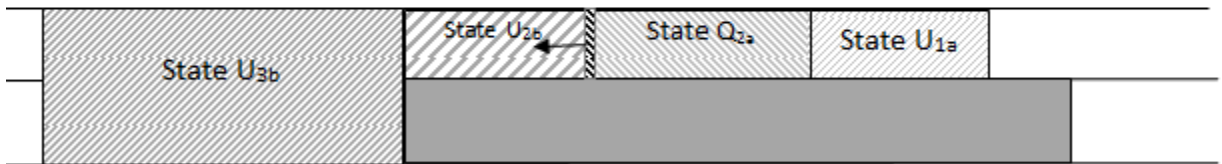

Figure 5B: Traffic states after diminishing State U_{2a}

Figure 3-5: Interaction Between Two Shockwave, Moving Toward Each Other A) Time t B) After Reaching the Same Location

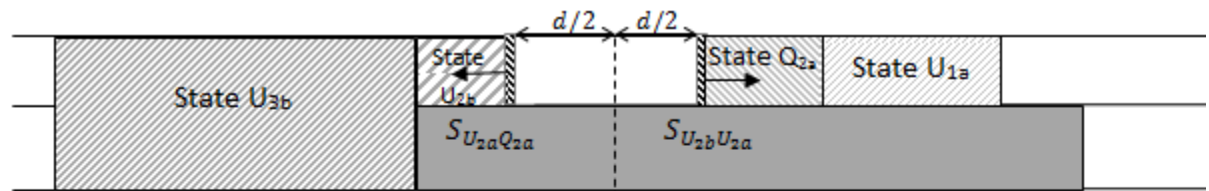

Figure 6A: Traffic states at time $t+\Delta t$ before adjustment

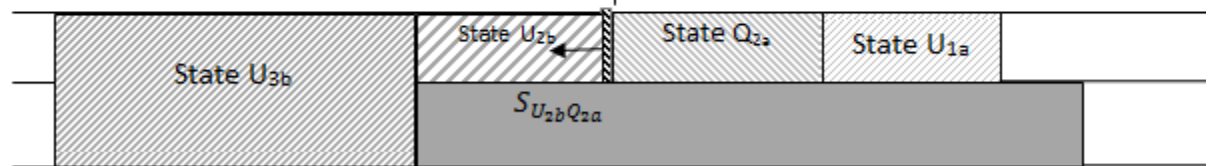

Figure 6B: Traffic states at time $t+\Delta t$ after adjustment

Figure 3-6: Adjustment in MovQ When Two Shockwave Move Toward Each Other A) Before Adjustment B) After Adjustment

3.3 INPUT AND OUTPUT DATA

The program includes five worksheets: 1) "Work Space Input" 2) "Buffer Distance Input" 3) "Two-lane Section Input" 4) "Demand Input" 5) "Run and Results"

In the first three worksheets, users enter the required input data to establish speed-flow curves for the three sections of the work zone. Demand data are given in the fourth worksheet and output data will be reported in the fifth worksheet. Input and output data are explained separately for each worksheet.

3.3.1 “Work Space Inputs”

The worksheet consists of three parts. 1) Input for Step zero 2) Input for step 1 3) Input for Steps 2-6.

The first part asks users to input time step length and interval length of the demand data. The geometric data of the section are entered in the second part and the work zone conditions inputs will be given in the third part. Input data are explained as below.

3.3.1.1 Inputs For Step Zero

Time Interval for Arrival Volume (Cell B16): The interval length (min) for which arrival volume is available is entered in cell B16. There are four options available: 5, 15, 30, and 60 min. The interval length should be selected based on the availability of the arrival data. If there are flexibilities in selecting the time interval, it is recommended to use 15-min interval for continuous queue and 5 min interval for intermittent queues. The definitions of these types of queue were brought in Chapter 2. Since the program reports the state of traffic at the end of each time interval, users can more accurately track evolution of traffic if a short interval is selected. Using 30-min and 60-min interval may mask some of the evolutions such as a queuing condition which lasts for 20 minute. Five-min interval is recommended for intermittent queues since usually these queues last for several minutes and using any interval longer than 5 minutes may not show formation of intermittent queue . However when continues queue is in the work zone, 15-min interval is expected to be adequate as these types of queue are expected to be longer than 15-min.

Time Step (Cell C16): The interval length to update the calculation is entered in cell C16. Five options are available for each interval length which is entered in cell B16. Table 3-1, shows the available options for each value determined in cell B16. When arrival data are given for a long interval, a very high level accuracy is not usually

expected. Thus very short time steps that most likely are not interesting in these situations are not available and instead users can choose larger ones. For example when 1-hr arrival data are used, the shortest time step is 1 sec. rather than 0.1 sec.

Table 3-1: Available time steps for different intervals for which arrival rates are given

		Interval length (min) for arrival volume			
		5	15	30	60
Options for time step (sec)	Option 1	0.1	0.5	0.5	1
	Option 2	1	5	10	15
	Option 3	15	30	30	30
	Option 4	30	60	60	60
	Option 5	60	120	120	120

As discussed in the Section 3.3.1, the time step should be selected considering the length of the sections. If the shortest section is 0.5 miles, the time step should be at least close to 10 sec. For other lengths of the shortest section, the recommended time step should be determined proportionally.

3.3.1.2 Geometric Inputs for Step 1

Section Length (Cell B20): Length of the Work Space in feet is entered in the cell B20. Figure 3-1A and 3-1B schematically define the length of the sections according to MUTCD definition.

Lane Width (Cell C20): The input for the cell C20 is the lane width in feet. According to HCM 2010 , it is defined as “the arithmetic mean of the lane widths of a roadway in one direction, expressed in feet”. The default value is 12 ft. The lane width must be between 8 ft. and 16 ft.

Left Shoulder Width (Cell D20): The input for cell D20 is the left shoulder width in feet from the left edge of the travel lane to the median.

The default value is 2 ft., and the left shoulder width must be less than or equal to 16 ft.

Right Shoulder Width (Cell E20): The input for cell E20 is the right shoulder width in feet from the right edge of the travel lane to the edge of the traffic control devices (TCD). The traffic control devices can be cones, concrete barriers, etc... the default value is 6 ft., and the right shoulder width must be less than or equal to 16 ft.

3.3.1.3 Work Zone Condition Inputs for Steps 2-6

This part of the worksheet starts from the column D and ends with the column K. Each row of the columns belongs to a particular interval of analysis. The beginning and end of the intervals and corresponding input data are introduced as below:

Start Time (Column B): Column B shows the start time of a particular interval in question. When the interval length for analysis is specified by the user, the start times shown in column B are updated automatically by the workbook. Users are not allowed to modify the cells in column B.

End Time (Column C): Column C shows the end time of a particular interval in question. When the interval length for analysis is specified by the user, the end times shown in column C are updated automatically. Users are not allowed to modify the cells in column C.

Specifying Time Intervals to be Analyzed (Column D): Each cell in column D has a dropdown list that returns either “N” or “Y”. By using the dropdown lists, users specify the time periods to be analyzed. The default entry for column D is “N”. For all time periods to be analyzed, users should select “Y” from the dropdown lists of the corresponding cells in column D. For instance, the interval length is 60 min, and the user wants to analyze the time period from 2:00 PM to 3:00 PM. Then the user should select “Y” from the dropdown list of the cell in column D that is in the same row as the desired time period.

In Steps 2-6, input data into Column D should be entered in the first place. Otherwise, if users do not specify the time periods to be analyzed, the workbook does not display the input cells in columns E through K.

Presence of Work Activity (Column E): Each cell in column E has a dropdown list that returns either “N” or “W”. By using the dropdown lists, users select the time period during which the crew will be working. The default entry for column E is “N”, which assumes no work activity. For all time periods with work activity, users should select “W” from the dropdown lists of the corresponding cells in column E.

Presence of Flagger (Column F): Each cell in column F has a dropdown list that returns either “N” or “F”. By using the dropdown lists, users select the time periods during which a flagger will be present in the work zone. The default entry for column F is “N”, which assumes no flagger. For all time periods with flagger, users should select “F” from the dropdown lists of the corresponding cells in column F.

Speed Limit (Column G): The input in column G is the work zone speed limit. Each cell in column G has a dropdown list that returns either “45” or “55”. By using the dropdown lists, users specify the work zone speed limit in mph for the time periods to be analyzed. The default entry for column G is “55”, which assumes a speed limit of 55 mph. If the speed limit for a particular interval is 45 mph, users should select “45” from the dropdown list of the corresponding cell in column G.

Work Zone Type (Column H): The input for column H is the work zone type. Each cell in column H has a dropdown list that returns either “S” or “L”. Column H requires input data only for the time periods with work activity. By using the dropdown lists, users specify whether the work zone is short-term or long-term for the time periods to be analyzed. The default entry for column H is “L”, which assumes long-term work zone. If a short-term work zone is analyzed in a particular interval, users should select “S” from the dropdown list of the corresponding cell in column H. For the time periods with no work activity, users are not allowed to enter input data in column H. Short-term work zones are those where the work space is generally separated from the traffic by means of easily portable devices such as like cones and barrels. On the other hand, concrete barriers are usually utilized to separate the traffic from the work space in long-term work zones.

Work Intensity (Column I): The input for column H is the work intensity. Each cell in column I has a dropdown list that returns either “L”, “M”, or “H”. Similar to

column H, column I also requires input data only for the time periods with work activity. By using the dropdown lists, users specify the level of work intensity for the time periods to be analyzed. The default entry for column I is “M”, which assumes “moderate” work intensity. If there is “high” work intensity in a particular time period, users should select “H” from the dropdown list of the corresponding cell in column I. Likewise, if there is “low” work intensity in a particular time period, users should select “L” from the dropdown list of the corresponding cell in column I. For the time periods with no work activity, users are not allowed to enter input data in column I. Users can refer to Appendix 1 of this report for the detailed definition of “low”, “moderate”, and “high” work intensity.

Speed Reduction due to Treatment (Column J): Sometimes, there may be an additional speed reduction treatment in the work zone such as police presence, speed photo enforcement, changeable message signs, etc... If there is an additional speed reduction treatment in the work zone during a particular time period, users enter the estimated speed reduction due to the treatment in the corresponding cell of column J. The estimated mean speed reductions due to various treatments can be taken from Table A-6. If there is no additional speed reduction treatment, column J should be left blank.

Speed Reduction due to Other Factors (Column K): If there are other speed-reducing factors not considered so far, users enter the estimated speed reduction due to those factors in column K. Such factors can be inclement weather conditions, temporarily reduced lane/ shoulder width, etc... If there are no such other factors, column K should be left blank.

3.3.2 **“Buffer Distance Inputs” And “Two-lane Section Inputs”**

It is assumed that there is no work activity in these sections, since work activity is supposed to happen in the Work Space. Hence, the following input data, related to work activity are not available for these sections: presence of work activity, presence of flagger, type of work zone, and work intensity level. The rest of the input data and their cell addresses are the same as those for “Work Space Input”. For example one can enter the lane widths of the three sections in the cell C20 of the corresponding worksheets.

3.3.3 “Demand Input”

Both arriving volume and initial queue conditions (i.e. unmet demand) are determined in this worksheet.

Initial Queue Conditions (Cells B6 to E6): From the drop-down menu in row 6, one can select one of the following five initial queue conditions:

- 1) No queue
- 2) Back of queue in the Buffer Distance and front of it in the Work Space (WS)
- 3) Back of queue in the Two-lane Section and front of it in WS
- 4) Back of queue in the Two-lane Section and front of it in the Transition Area (TA)
- 5) Two queues: Back of queue1 is in the Buffer Distance and front of it in WS, back of queue2 in the two-lane section and front of it in TA

Length of Queue (cells 9B to 9C and cells 12B to 12C): In Initial Conditions 2 to 4, there is only one queue in the work zone. The length of queue (ft) should be entered in cells 9B to 9C, merged. In the fifth Initial Condition there are two separate queues in the work zone. The queues are named “queue 1” and “queue 2”. The front of “queue 1” is in the Work Space and back of it is in the Buffer Distance. While, the front of “queue 2” is in the Transition Area and its back is in the Two-lane Section. The lengths for “queue 1” ,and “queue 2” should be entered in merged cells 9B to 9C ,and 12B to 12C, respectively.

Arrival Volume for Initial Queues (cells 9D to 9E and cells 12D to 12E): when there is only one initial queue, arriving volume is entered in vph only into merged cells 9D to 9E. When there are two queues in the work zone, arriving volume for “queue1” is entered into merged cells 9D to 9E, and it is input into the merged cells 12D to 12E for “queue2”. The front of “queue1” is in the Work Space and back of it is in the Buffer distance. The front of “queue2” is in the Transition Area and back of it is in the Two-lane Section.

PCE (Cell B17): The input for cell B17 is the passenger car equivalent (PCE), which is defined in HCM 2010 as the “the number of passenger cars that are displaced by a single heavy vehicle of a particular type under prevailing roadway, traffic, and control

conditions”. HCM 2010- suggests a PCE of 1.5 for level terrain, 2.5 for rolling terrain, and 4.5 for mountainous terrain for basic freeway sections. The cell B17 has a dropdown list that returns either 1.5, 2.5, or 4.5. The default value is 1.5. If the PCE is computed for a specific condition and differs from the values given in the dropdown list, users are allowed to enter the computed value in cell B17. The maximum allowable entry is 7.0 as suggested by the HCM 2010. On the other hand, the minimum allowable entry is 1.0.

Start Time (Column B): Column B is the same as column B of the worksheet “Work Space Input”. Users are not allowed to modify these cells.

End Time (Column C): Column C is the same as column B of the worksheet “Work space Input”. Users are not allowed to modify these cells.

Expected Hourly Traffic Demand (Column D): The input for column D is the hourly traffic demand, measured in the two-lane section in vehicles per hour (vph).

Percentage of Single-Unit Trucks (Column E): The input for column E is the percentage of single-unit trucks. The default value is 5%. Single-unit trucks have more than four tires touching the pavement, so the percentage of single-unit trucks excludes vans and pickup trucks.

Percentage of Multiple-Unit Trucks (Column F): The input for column F is the percentage of multiple-unit trucks. The default value is 5%. According to AASHTO 2001, multiple-unit (combination) trucks consist of “a single-unit truck with a full trailer, a truck tractor with a semitrailer, or a truck tractor with a semitrailer and one or more full trailers”.

3.3.4 Output Data from Worksheet “Work Space Input”

Some of the outputs are placed in the input sheets to let users immediately observe the effect of inputs on the related outputs. Then users are able to find some of the inputs that cause unreasonable results. As explained in the color coding section, the title cells of the outputs has a Navy Blue background with white text. This section involves in-depth explanation of the outputs that each worksheet returns. The output data described in the following subsections are obtained only if users enter the required input data properly.

3.3.4.1 Outputs From Step 1

Speed Reduction due to Lane Width (Cell F20): The output in cell F20 is the estimated speed reduction in mph due to lane width. It is computed based on Table A-1.

Speed Reduction due to Left Shoulder Width (Cell G20): The output in cell G20 is the estimated speed reduction in mph due to left shoulder width. It is computed based on Table A-1.

Speed Reduction due to Right Shoulder Width (Cell H20): The output in cell H20 is the estimated speed reduction in mph due to right shoulder width. It is computed based on Table A-1.

3.3.4.2 Outputs From Step2-6

In the second part of the worksheet, users obtain the output data from four columns. Each row corresponds to a particular interval for analysis. The workbook returns no outputs for the intervals that are not selected for analysis. The four output columns are described as follows:

Free-Flow Speed (Column L): The output in column L is the free-flow speed in mph. The free-flow speed is computed without considering the speed-reducing effects such as shorter-than-ideal lane width, work intensity, etc... If the work zone speed limit is 55 mph, column L returns a free-flow speed of 62 mph. If the work zone speed limit is 45 mph and there is no flagger, column L returns a free-flow speed of 55 mph. If the work zone speed limit is 45 mph and there is flagger, column L returns a free-flow speed of 43 mph.

Speed Reduction due to Work Intensity (Column M): The output in column M is the estimated speed reduction in mph due to work intensity. It is computed based on Table A-4 for short-term work zones and Table A-5 for long-term work zones.

Adjusted Free-Flow Speed (Column N): The output in column N is the adjusted free-flow speed in mph. The adjusted free-flow speed is computed based on Equation 1A. the adjusted free-flow speed is computed by considering the speed-reducing effects of work intensity, less-than-ideal lane/ shoulder width, additional speed reduction treatments (if they exist), etc...

Maximum Flow Rate (Column O): The output in column O is the estimated maximum flow rate in passenger cars per hour per lane (pcphpl) that can be maintained in the work zone under the prevailing conditions. The maximum flow rate is computed based on the four-regime speed-flow curves given in Figures 3-1A to 3-3A.

3.3.5 Output Data from Worksheets “Buffer Distance Input” and “Two-lane Section Input”

The description of the output data and their addresses in the worksheets is the same as those for the worksheet “Work Space Input”.

3.3.6 Output Data from Worksheet “Demand Input”

This worksheet involves two output columns that are described as follows:

Heavy Vehicle Adjustment Factor (Column G): The output in column G is the heavy vehicle adjustment factor. It is computed based on Equation 3A.

Adjusted Demand (Column H): The output in column H is the adjusted demand in passenger cars per hour per lane (pcphpl). It is computed based on Equation 6A.

3.3.7 Output Data from Worksheet “Run and Results”

Results are reported in columns D to I for the Work Space, in columns K to P for the Buffer Distance, and in columns R to W for the Two-lane Section. The outputs are explained as below:

Queue State (Columns D, K, and R): This columns indicate if the traffic states which exist at the end of the interval is in queuing condition or not. The queuing traffic states are shown by “Yes” and non-queuing traffic states are denoted by “No”.

Location of the Front of a Traffic State (columns E, L, and S): This information is provided for queuing states. The location of the front of a traffic state is measured from the beginning of the Two-lane Section(i.e. the section 3) and reported in feet.

Location of the Rear of a Traffic State (columns F, M, and T): This information is provided for queuing states. The location of the rear of a traffic state is measured from the beginning of the Two-lane Section (i.e. the section 3) and reported in feet.

Exit Flow (Columns G, N, and U): Flow rate of the traffic states which exist at the end of the analysis interval are shown in Columns F, M, and T.

Speed (Columns H, O, and V): Speed of the traffic states which exist at the end of the analysis interval are shown in Columns E, L, and S.

Delay (Columns I, P, and W): Total delay experienced due to each traffic state is reported in hour.

3.4 *TUTORIALS*

The MovQ is a Microsoft Excel-based workbook, so all Microsoft Excel users are familiar to its interface. The prospective user of the workbook needs to have Microsoft Excel 2007 or higher running on a Windows-based computer. The use of the earlier versions of Microsoft Excel is not recommended as it may lead to incompatibility issues. Moreover, users must enable the macros in MovQ subsequent to opening it. Otherwise, the software will not work. This chapter explains how to start using the program including the process of enabling macros. Then two example problems are solved.

3.4.1 **Getting Started**

This subsection explains how to open the computer program and enable the macros prior to analysis.

Double click the Excel file “MovQ.xlsx” to open a blank workbook. If you are using MS Excel 2010, the program gives a security warning as shown on the right-hand side. Click on the “Enable Contents” button to allow the use of the macros in the workbook.

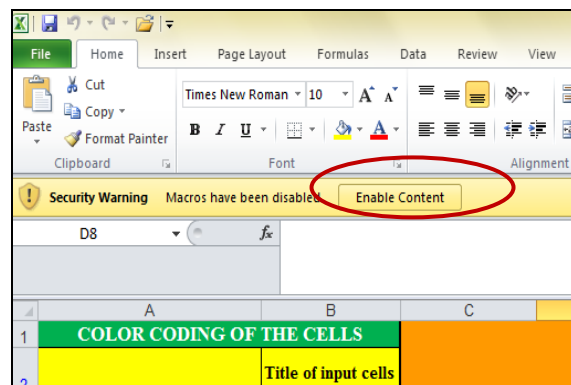

If you are using MS Excel 2007, the program gives a security warning as shown on the upper row of the following figure. Click on the “Options” button. “Microsoft Office Security Options” dialog box appears. Check the option “Enable the content” as shown on the right-hand side, and then click “OK” to close the dialog box. The macros in the workbook are enabled.

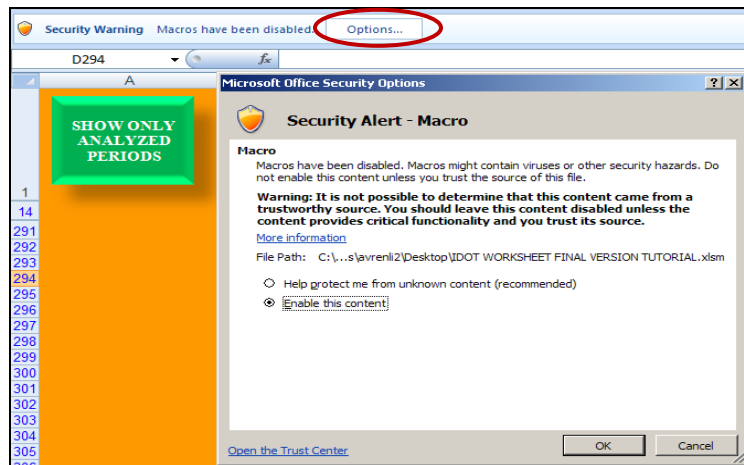

If you are using MS Excel 2007, click the MS Office button on the upper left corner of the workbook. If you are using MS Excel 2010, click the “File” button on the upper left corner of the workbook. Then in both versions, choose “Save As” from the menu and save your file with a different name.

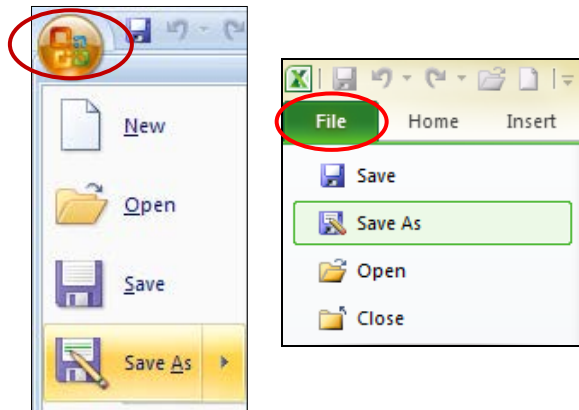

3.4.2 Example Problems

In this section, two example problems are solved. Both the problems analyze queuing conditions for a work zone with flagger and work activity. In the first problem there is no initial queue while in the second one there is a queue in the beginning of the analysis. In the first problem, demand exceeds capacity in the middle of the analysis but the study period was selected such that there is a queue at the end of the analysis. The second problem is the continuation of the first one until queue dissipates. In the second problem, users learn how to interpret the final results of the first problem as the inputs of the second problem.

3.4.2.1 Example Problem 1

In this example problem, a short term work zone is to be analyzed for 45 minutes. Lane width through the Work Space and Buffer Distance is 11 ft and there are 1ft left and right clearances within these two sections. Also, lane width, left and right lateral clearances are ideal within the two-lane section. The length of the Work Space, the Buffer Distance and the Two-lane Section are 2500 ft, 4000 ft, and 4600 ft, respectively. A flagger in the beginning of the Work Space shows a “Slow Down” paddle to traffic and work activity has moderate intensity. The speed limit is 45 mph within both the Work Space and the Buffer Distance, and it is 55 mph through the Two-lane Section. Three 15-min arrival data, from 4:00 PM to 4:45 PM, are available as follow: 900 vph, 1100 vph, and 900 vph, respectively. The work zone is on level terrain and 2% of traffic is single-unit trucks and 8% are multiple-unit trucks. Also, no queue exists in the beginning of the interval.

Th rest of the problem explains how to input the data into each worksheet.

Inputs for the Work Space: step zero

First open the file “MovQ.xlsx” as explained in Section 3.4.1. Then start with the worksheet named “Work Space Input”. Since 15-min arrival volume is given, interval length of 15 is selected from the dropdown menu in cell B16, as shown in the following figure.

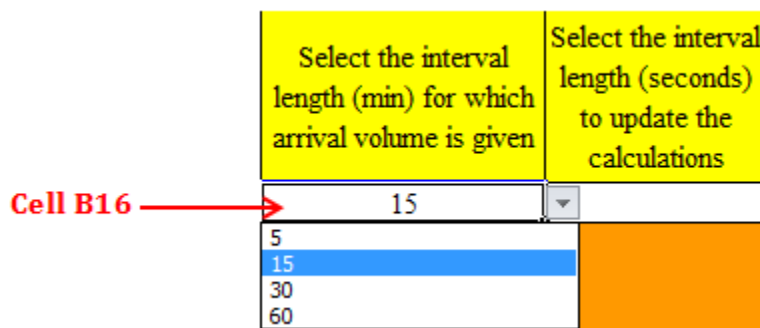

Time step of 30 seconds is chosen from cell C16. Depending on the desired accuracy, one can select a different time step.

Select the interval length (min) for which arrival volume is given	Select the interval length (seconds) to update the calculations
15	30 ← Cell C16
	0.5 5 30 60 120

Inputs for the Work Space: geometric data

All the geometric data must be entered into the workbook in feet. According to the problem description the geometric data for the Work Space are:

Work Space Length=2500 ft, Lane width=11 ft, Left lateral clearance=1 ft, and Right lateral clearance=1ft

These data are input in cells B20 through E20 as below:

Enter the work space length (ft)	Enter the lane width (ft)	Enter the left shoulder width (ft)	Enter the right shoulder width (ft)
2500.0 ← Cell B20	11.0	1.0	1.0 ← Cell E20

The program computes speed reductions due to non-ideal geometric conditions in cells F20 through H20, as shown by the following figure.

Computed speed reduction due to lane width (mph)	Computed speed reduction due to left shoulder (mph)	Computed speed reduction due to right shoulder (mph)
1.9 ← Cell F20	1.0	3.6 ← Cell H20

Inputs for the Work Space: work zone conditions

Select “Y” from the drop down menu in cells D88 through D90 to choose the three intervals, from 4:00 PM to 4:45 PM.

		Start of Time Interval	End of Time Interval	Put "Y" for the intervals to be analyzed. (Column D)	Put th wh (C
23					
88		4:00 PM	4:15 PM	Y	
89		4:15 PM	4:30 PM	Y	
90		4:30 PM	4:45 PM	N	
91		4:45 PM	5:00 PM	N	
92		5:00 PM	5:15 PM	N	

After specifying the study intervals, the columns E, F, G, J and K, are activated as shown below however they have default values which may be changed according to the problem description.

Start of Time Interval	End of Time Interval	Put "Y" for the intervals to be analyzed. (Column D)	Put "W" for the intervals when crew is working. (Column E)	Put "F" for the intervals when flagger is present. (Column F)	Put "45" for the intervals if the speed limit is not 55 mph. (Column G)	If crew is working, put "S" for short-term work zones, and put "L" for long-term work zones. (Column H)	If the crew is working, put "L" for low work intensity, put "M" for moderate work intensity, and put "H" for high work intensity. (Column I)	If there is any additional speed reduction (mph) due to treatments/ TCD given in Table 6 of the report, enter that speed reduction. Otherwise, leave it blank. (Column J)	If there is any additional speed reduction (mph) due to any other factors not considered so far, enter that speed reduction. Otherwise, leave it blank. (Column K)
4:00 PM	4:15 PM	Y	N	N	55.0				
4:15 PM	4:30 PM	Y	N	N	55.0				
4:30 PM	4:45 PM	Y	N	N	55.0				

Since there is work activity in the work zone, “W” should be selected from the drop down menus in the column E. Thereafter columns H and I, related to work zone type and work intensity level, are activated as displayed below.

Start of Time Interval	End of Time Interval	Put "Y" for the intervals to be analyzed. (Column D)	Put "W" for the intervals when crew is working. (Column E)	Put "F" for the intervals when flagger is present. (Column F)	Put "45" for the intervals if the speed limit is not 55 mph. (Column G)	If crew is working, put "S" for short-term work zones, and put "L" for long-term work zones. (Column H)	If the crew is working, put "L" for low work intensity, put "M" for moderate work intensity, and put "H" for high work intensity. (Column I)	If there is any additional speed reduction (mph) due to treatments/ TCD given in Table 6 of the report, enter that speed reduction. Otherwise, leave it blank. (Column J)	If there is any additional speed reduction (mph) due to any other factors not considered so far, enter that speed reduction. Otherwise, leave it blank. (Column K)
4:00 PM	4:15 PM	Y	W	N	55.0	L	M		
4:15 PM	4:30 PM	Y	W	N	55.0	L	M		
4:30 PM	4:45 PM	Y	N	N	55.0				
4:45 PM	5:00 PM	N	N	N					
5:00 PM	5:15 PM	N	N	N					

Then "F" is chosen from the drop down menus in the column F as there is a flagger in the work zone. Speed limit of 45 is input in the column G. Also, "S" and "M" are entered in the columns H and I since the work zone is short term and work intensity level is moderate. There is no additional speed reducing cause or any other traffic control device. Thus the columns J and K are left blank then the input cells for the three intervals should be as shown below.

Start of Time Interval	End of Time Interval	Put "Y" for the intervals to be analyzed. (Column D)	Put "W" for the intervals when crew is working. (Column E)	Put "F" for the intervals when flagger is present. (Column F)	Put "45" for the intervals if the speed limit is not 55 mph. (Column G)	If crew is working, put "S" for short-term work zones, and put "L" for long-term work zones. (Column H)	If the crew is working, put "L" for low work intensity, put "M" for moderate work intensity, and put "H" for high work intensity. (Column I)	If there is any additional speed reduction (mph) due to treatments/ TCD given in Table 6 of the report, enter that speed reduction. Otherwise, leave it blank. (Column J)	If there is any additional speed reduction (mph) due to any other factors not considered so far, enter that speed reduction. Otherwise, leave it blank. (Column K)
4:00 PM	4:15 PM	Y	W	F	45.0	S	M		
4:15 PM	4:30 PM	Y	W	F	45.0	S	M		
4:30 PM	4:45 PM	Y	W	F	45.0	S	M		

The column O of the worksheet (see the following figure) returns the Work Space capacity which is 1012 pcph during the three intervals.

Computed free flow speed (mph) (Column L)	Computed speed reduction due to work intensity (mph) (Column M)	Computed adjusted free-flow speed (mph) (Column N)	Computed maximum flow rate (pcph) (Column O)
43.0	12.0	24.5	1,012
43.0	12.0	24.5	1,012
43.0	12.0	24.5	1,012

Inputs for the Buffer Distance: geometric data

After completing data input for the Work Space, the worksheet, called “Buffer Space” is selected to enter the data. Length of the Buffer Distance is 4000 ft and the rest of the geometric inputs are the same as those for the Work Space. The input cells and the corresponding speed reductions are shown as below

Enter the length of the buffer distance (ft)	Enter the lane width (ft)	Enter the left shoulder width (ft)	Enter the right shoulder width (ft)	Computed speed reduction due to lane width (mph)	Computed speed reduction due to left shoulder (mph)	Computed speed reduction due to right shoulder (mph)
4000.0	11.0	1.0	1.0	1.9	1.0	3.6

Inputs for the Buffer Distance: work zone conditions

Since work activity is not supposed to happen in the Buffer Distance, all the work activity-related columns which are the columns D, E, F, H, and I are grey meaning that they are deactivated, and users are not allowed to enter any inputs. Speed limit of the section is 55 mph and there is no additional speed reducing factor hence the input cells and the corresponding speed reductions should be like below. According to the column O of the figure, the Buffer Distance capacity is estimated to be 1629 pcph.

Put "45" for the intervals if the speed limit is not 55 mph.			If there is any additional speed reduction (mph) due to treatments/ TCD given in Table 6 of the report, enter that speed reduction. Otherwise, leave it blank. (Column J)	If there is any additional speed reduction (mph) due to any other factors not considered so far, enter that speed reduction. Otherwise, leave it blank. (Column K)	Computed free flow speed (mph) (Column L)	Computed speed reduction due to work intensity (mph) (Column M)	Computed adjusted free-flow speed (mph) (Column N)	Computed maximum flow rate (pcph) (Column O)
55.0					62.0		55.5	1,629
55.0					62.0		55.5	1,629
55.0					62.0		55.5	1,629

Inputs for the Two-lane Section: geometric data

To enter the input data for the Two-lane Section, the corresponding worksheet is selected. The length of the Two-lane Section is 4600 ft and the other geometric conditions are ideal, meaning that lane width is 12 ft, and left and right shoulder widths are 2 ft and 6 ft, respectively. Thus there is no speed reduction due to the geometric characteristics as computed by the program (see the output cells in following figure)

Enter the length of two-lane section (ft)	Enter the lane width (ft)	Enter the left shoulder width (ft)	Enter the right shoulder width (ft)	Computed speed reduction due to lane width (mph)	Computed speed reduction due to left shoulder (mph)	Computed speed reduction due to right shoulder (mph)
4600.0	12.0	2.0	6.0	0.0	0.0	0.0

Inputs for the Two-lane Section: work zone conditions

Work zone condition data for the Two-lane Section is the same as those for the Buffer Distance as shown below

Put "45" for the intervals if the speed limit is not 55 mph.			If there is any additional speed reduction (mph) due to treatments/ TCD given in Table 6 of the report, enter that speed reduction. Otherwise, leave it blank. (Column J)	If there is any additional speed reduction (mph) due to any other factors not considered so far, enter that speed reduction. Otherwise, leave it blank. (Column K)	Computed free flow speed (mph) (Column L)	Computed speed reduction due to work intensity (mph) (Column M)	Computed adjusted free-flow speed (mph) (Column N)	Computed maximum flow rate (pcph) (Column O)
55.0					62.0		62.0	3,600
55.0					62.0		62.0	3,600
55.0					62.0		62.0	3,600

Inputs for demand: initial queue

The worksheet called "Demand input" is selected. Since no queue exists in the beginning of interval, "No queue" is selected from the drop down menu in the cells B6 to E6, merged

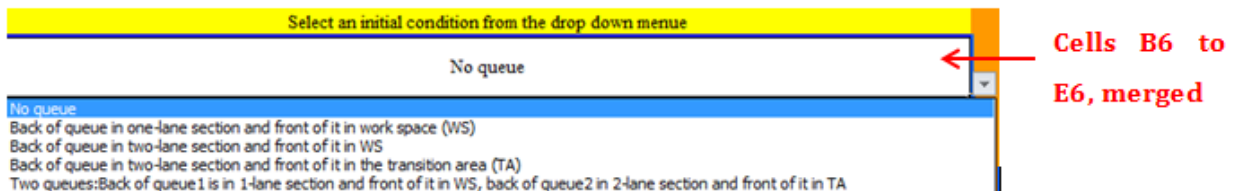

Inputs for demand: traffic demand and percent truck

The work zone is on a level terrain thus the PCE value of 1.5 is selected from the drop down menu in cell B17.

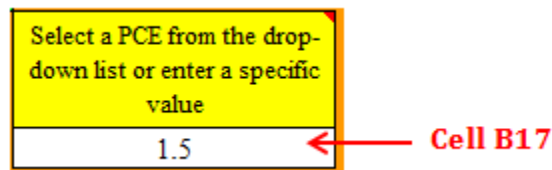

Arriving volume is 900 vph, 1100 vph, and 900 vph for the three intervals, also traffic is composed of 2% single-unit truck and 8% multiple-unit truck. These values are entered in the columns D to F for the study intervals. As shown in the following figure, the final output of this step is the adjusted demand in column H.

	B	C	D	E	F	G	H
21	Start of Time Interval	End of Time Interval	Enter the expected hourly traffic demand during the interval (vph) (Column D)	Enter the percentage of single unit trucks (%) (Column E)	Enter the percentage of multiple-unit trucks (%) (Column F)	Computed heavy vehicle adjustment factor (Column G)	Computed adjusted demand (pcph) (Column H)
86	4:00 PM	4:15 PM	900	2.0%	8.0%	0.95	945
87	4:15 PM	4:30 PM	1,100	2.0%	8.0%	0.95	1,155
88	4:30 PM	4:45 PM	900	2.0%	8.0%	0.95	945

Run the program

To run the program, the worksheet called “Run and Results” is selected and then the button located at the left corner of the worksheet is clicked.

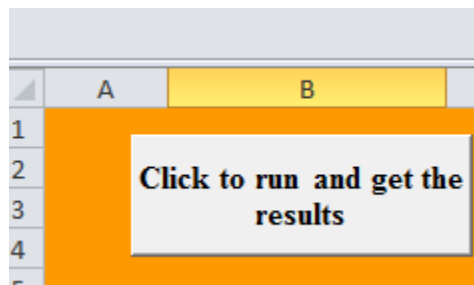

Results for the Work Space

Information on the traffic states that exist at the end of each time intervals is reported for each section. None of these traffic states are queuing as indicated by “No” in the column D. One can conclude from the results that the traffic state with volume of 963 vph starts propagating somewhere in the middle of the second interval (4:15PM to 4:30PM) and the Work Space will be completely under this traffic state at end of the interval. The speed of the traffic states is lower than the speed limit and causes a total delay which is listed for each interval in the column I.

	A	B	C	D	E	F	G	H	I
1									
2		Click to run and get the results		Results for Work Space					
3									
4	Queue State			Exit Flow (vph)	Speed (mph)	Delay (veh-hr)			
5	Yes or No	Front	Rear						
6		4:00 PM	4:15 PM	No			900	20.3	3.02
7									
8									
9									
10		4:15 PM	4:30 PM	No			963	18.5	5.76
11		4:15 PM	4:30 PM						
12									
13									
14		4:30 PM	4:45 PM	No			963	18.5	6.77
15		4:30 PM	4:45 PM						

Results for the Buffer Distance

For the Buffer Distance there is no queue at the end of the first interval but queue exist at the end of the second interval as indicated by “Yes” in the cell K10 in the following figure. This means that the wave with the volume of 1100 vph reached the beginning of the Work Space during the interval. Since the volume of this wave is greater than the capacity of the Work Space, 963 vph, queue starts building up. The front and rear of the queue are located at 8600 ft and 5039 ft (see the cells L10 and M10 in the following figure) from the beginning of the Two-lane Section. The difference between these two values, 3561 ft, is the queue length in the Buffer Distance at the end of the second interval. At the end of the third interval the back of queue is at the 6748 ft from the beginning of the work space thus the queue length is 1852 ft. This queue length reduction happened since the arriving volume, 900 vph, dropped below the Work Space capacity, 963 vph, during the third interval.

	A	B	C	K	L	M	N	O	P
1									
2									
3				Results for Buffer Distance					
4				Queue State			Exit Flow (vphpl)	Speed (mph)	Delay (veh-hr)
5				Yes or No	Front	Rear			
6		4:00 PM	4:15 PM	No			900	54.9	0.00
7									
8									
9									
10		4:15 PM	4:30 PM	Yes	8600	5039	963	15.0	3.58
11		4:15 PM	4:30 PM	No			1100	54.2	0.05
12									
13									
14		4:30 PM	4:45 PM	Yes	8600	6748	963	15.0	6.34
15		4:30 PM	4:45 PM	No			900	54.9	0.00

During the three analysis intervals, there is no queue and delay in the Two-lane Section. The flow rate of these states are equal to the demand, entered in the column D of the “Demand Input” worksheet.

	A	B	C	R	S	T	U	V	W
1									
2									
3				Results for the Two-lane Section					
4				Queue State			Exit Flow (vph)	Speed (mph)	Delay (veh-hr)
5				Yes or No	Front	Rear			
6		4:00 PM	4:15 PM	No			900	62	0
7									
8									
9									
10		4:15 PM	4:30 PM	No			1100	62	0
11		4:15 PM	4:30 PM						
12									
13									
14		4:30 PM	4:45 PM	No			900	62	0
15		4:30 PM	4:45 PM						

3.4.2.2 Example Problem 2

The work zone introduced in example problem 1 is analyzed for another 30 minutes (two 15-min intervals) with demand of 850 and 800 vph during the first and second interval, respectively. The initial condition of this study period is the same as the traffic conditions at the end of the analysis in the example problem 1 and the rest of the data are the same as those in example problem 1.

Inputs for the three sections: the Work space, the Buffer distance, and the Two-lane Section

To enter the inputs for these sections one needs to follow the same steps as explained for the example problem 1 except the data should be entered for two time intervals, from 4:45 PM to 5:15 PM.

Inputs for demand: initial queue

The results of the example 1 for the last interval showed that there is only one queuing states in the work zone and that is located in the Buffer Distance. Hence front of queue is at the beginning of Work Space and back of it, is in the Buffer Distance as determined in the following figure.

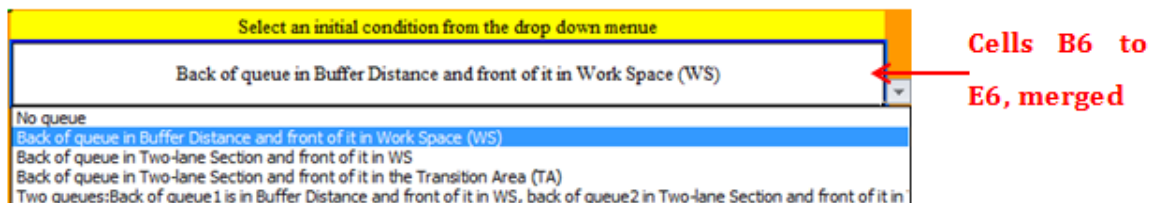

As discussed in Example 1, queue length at the end of the analysis is 1096 ft and the traffic state upstream of queue has a volume of 900 vph. Thus these data are input as below:

Cells B9 and C9, merged →

Enter an approximate length for the queue (ft)	Enter arrival rate (vph) for the queue
1852	900

 ← Cells D9 and E9, merged

Run the program

To run the program, the button located at the left corner of the worksheet “Run and Results” should be clicked.

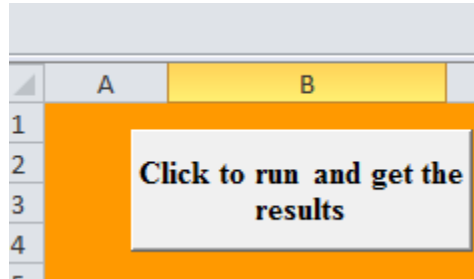

Results for the WorkSpace

During the first interval, exit flow is 963 but arriving flow rate drops to 800 vph in the second interval. Delay due to each traffic state is shown in column I as the traffic speeds are below the speed limit, 45 mph, within the analysis period.

	A	B	C	D	E	F	G	H	I																					
1	<div style="display: flex; justify-content: space-between; align-items: center;"> <div style="border: 1px solid gray; padding: 5px; background-color: white;">Click to run and get the results</div> <div style="background-color: yellow; padding: 5px; border: 1px solid gray;"> Results for Work Space <table border="1" style="margin-left: auto; margin-right: auto; border-collapse: collapse;"> <thead> <tr> <th colspan="3">Queue State</th> <th rowspan="2">Exit Flow (vph)</th> <th rowspan="2">Speed (mph)</th> <th rowspan="2">Delay (veh-hr)</th> </tr> <tr> <th>Yes or No</th> <th>Front</th> <th>Rear</th> </tr> </thead> <tbody> <tr> <td style="background-color: darkblue; color: white;">No</td> <td style="background-color: darkblue; color: white;"></td> <td style="background-color: darkblue; color: white;"></td> <td style="background-color: darkblue; color: white;">963</td> <td style="background-color: darkblue; color: white;">18.5</td> <td style="background-color: darkblue; color: white;">3.82</td> </tr> <tr> <td style="background-color: darkblue; color: white;">No</td> <td style="background-color: darkblue; color: white;"></td> <td style="background-color: darkblue; color: white;"></td> <td style="background-color: darkblue; color: white;">800</td> <td style="background-color: darkblue; color: white;">21.3</td> <td style="background-color: darkblue; color: white;">2.32</td> </tr> </tbody> </table> </div> </div>									Queue State			Exit Flow (vph)	Speed (mph)	Delay (veh-hr)	Yes or No	Front	Rear	No			963	18.5	3.82	No			800	21.3	2.32
Queue State										Exit Flow (vph)	Speed (mph)	Delay (veh-hr)																		
Yes or No													Front	Rear																
No												963	18.5	3.82																
No			800	21.3	2.32																									
2																														
3																														
4																														
5																														
6		4:45 PM	5:00 PM	No																										
7		4:45 PM	5:00 PM																											
8																														
9																														
10		5:00 PM	5:15 PM	No																										

Results for the Buffer Distance

at the end of the first interval, Back of queue is at 8326 ft from the beginning of the two-lane section thus the resulting queue length is 274 ft and the arriving volume is 850 vph. During the second interval arriving volume drops to 800 vph and queue dissipates.

	A	B	C	K	L	M	N	O	P			
1												
2												
3							Results for Buffer Distance					
4							Queue State					
5							Yes or No	Front	Rear	Exit Flow (vphpl)	Speed (mph)	Delay (veh-hr)
6		4:45 PM	5:00 PM	Yes	8600	8326.06931				963	15.0	4.03
7		4:45 PM	5:00 PM	No						850	55.1	0.00
8												
9												
10		5:00 PM	5:15 PM	No						800	55.2	0.00

Results for the Two-lane Section

The results showed no queue in the Two-lane Section and no delay is expected to be experienced by drivers since the speed of the traffic state is above the speed limit, 55 mph.

	A	B	C	R	S	T	U	V	W			
1												
2												
3							Results for the Two-lane Section					
4							Queue State					
5							Yes or No	Front	Rear	Exit Flow (vph)	Speed (mph)	Delay (veh-hr)
6		4:45 PM	5:00 PM	No						850	62	0
7		4:45 PM	5:00 PM									
8												
9												
10		5:00 PM	5:15 PM	No						800	62	0

CHAPTER 4. CONCLUSIONS

Two computer programs, IntQ and MovQ, were developed to study intermittent queues and moving queues, respectively.

IntQ is a mesoscopic simulation program in which groups of vehicles are moved along the network under certain rules and the group characteristics are generated from statistical distributions. The rules determine the conditions when groups are combined, or how the groups are affected by a downstream conditions such as slow moving queue or flagger. Using statistical distributions for the group characteristics, results in modeling the stochasticities that exist in traffic, particularly the variations in group size, inter-group gap, average headway of the group, and the speed of the leader of the group. Also, the variations in arrival rate, interaction between groups of different sizes, and the effect of slow moving vehicles to create moving bottlenecks can be studied in IntQ. Alternatively one may consider using a microscopic simulation package to study intermittent queues, but that requires calibration for the group characteristics which is not a simple task. Also, since the IntQ is a mesoscopic model, it is expected to be faster than microscopic simulation packages. Moreover, the simulation rules were developed for when there is one lane open for traffic, and just one section of the network is the critical bottleneck thus they can be applied to similar conditions; however for other conditions new simulation rules should be added to make it appropriate for intermittent queue conditions.

Group characteristics were determined from field data. Three data sets were collected from work zones with speed limit of 55 mph, no work activity, and no treatments. The results of Chi-square test showed that fitted normal distributions were not significantly different ($P\text{-value} > 0.1$) from observed distributions for both the speed of group leaders, and the average headway of followers. Furthermore, shifted negative exponential distributions were fit to the group size distributions. Also shifted negative exponential, lognormal, and weibull distributions fit the inter-group gap distributions. It is recommended to use shifted negative exponential distribution for the inter-group gap distributions since it requires lower number of parameters to be estimated. Additionally,

the approximate hourly volume of the three data sets was 650, 930, and 1310 pcphpl (rounded to the nearest multiple of 10). When volume is different, but the other work zone conditions are similar, one can determine the parameters of the distributions by interpolation with respect to traffic volume. It is recommended to collect data and find distributions of the group characteristics for work zones with work activity, presence of treatment, and different speed limit.

Moreover, MovQ was programmed in VBA. The program develops speed-flow curves using the step-by-step procedure explained in the Appendix 1. In this method, the effect of non-ideal conditions such as work activity, narrow lane width and lateral clearances are reflected by reductions in free flow speed and then a speed-flow curve is developed based on the reduced free flow speed. Then shockwave theory is used to compute delay and queue length. Speed-flow curves are available to the following three conditions where one of the two lanes is open within the Work Space:

- 1) speed limit of 55 mph,
- 2) speed limit of 45 mph with no flagger, and
- 3) speed limit of 45 mph with flagger.

Additionally, the program has two features that can increase accuracy of the results compared with other methods.

1) MovQ can find capacity or discharge flow rate using speed-flow curves and that provides the flow rate for before and after breakdown conditions, while HCM 2010 or similar methods find capacity using regression equations and do not return flow rate for post break-down conditions. Hence the speed-flow curves enable users can find flow rate and operating speed in stop-and-go and break-down conditions. 2) MovQ considers two potential bottleneck locations (i.e. the Work Space and the Transition Area), estimates capacity for both locations, and uses shockwave theory to study how queues and waves interact with each other. While the other methodologies, do not simultaneously consider these locations and interaction between the bottlenecks in queuing analysis.

Finally, the MovQ assumes that arriving volume is uniform within an interval while the IntQ models non-uniform arrival pattern. The assumption of uniform arrival pattern in the MovQ will cause linear increase or decrease in queue length at a given

volume level. However sometimes fluctuation in queue length is noticeable and linear pattern is not enough to describe the real changes in queue length. Example of these cases could be when queuing condition intermittently exists in the field, or when some of the queuing periods last several minutes, followed by several minutes of non-queuing conditions. In these cases, it is recommended using the IntQ to model non-uniform arrival pattern. Generally it is recommended to use the IntQ when one is interested in finding queues which last shorter than the interval length for which arriving volume data are provided, or when queue length fluctuations within the interval is important.

REFERENCES

1. D. Sun, R. F. Benekohal, (2005), Analysis of work zone gaps and rear-end collision probability, *Journal of Transportation and Statistics*, 8 (2).
2. Federal Highway Administration, (2004), Final Rule on Work Zone Safety and Mobility, *Federal Register/ Rules and Regulations*, 69 (174).
3. Federal Highway Administration, (2009), Manual on Uniform Traffic Control Devices, Sec. 6c.04.
4. G.L. Ullman, R. J. Porter, G.J. Karkee, (2009), Monitoring Work Zone Safety and Mobility Impacts in Texas, Research Report FHWA/TX-09/0-5771-1, <http://tti.tamu.edu/documents/0-5771-1.pdf>.
5. H. Ramezani, R. Benekohal, (2012), Work zones as a series of bottlenecks: developing a methodology to estimate delay and queue length, presented at Transportation Research Board (TRB), Washington DC.
6. H. Ramezani, R. Benekohal, K. Avrenli, (2010), Methodology to estimate moving queue length and delay in highway bottlenecks. *Traffic Flow Theory and Characteristics Committee: Summer Meeting and Conference*, Annecy, France.
7. H. Ramezani, R. Benekohal, K. Avrenli, (2010), Statistical distribution for inter platoon gaps, intra-platoon headways and platoon size using field data from highway bottlenecks, *Traffic Flow Theory and Characteristics Committee: Summer Meeting and Conference*, Annecy, France.
8. H. Ramezani, R. Benekohal, K. Avrenli, (2011) Determining Queue and Congestion in Highway Work Zone Bottlenecks, <http://www.purdue.edu/discoverypark/nextrans/assets/pdfs/Year%202%20Final%20Reports/Final%20Report%20046.pdf>.
9. M.V. Chitturi, R.F. Benekohal, (2010), Work zone queue length and delay methodology. *Transportation Letters: The International Journal of Transportation Research*, 2(4), PP. 273-283.

10. M. V. Chitturi, R. F. Benekohal, A. Kaja-Mohideen, (2008), Methodology for computing delays and users costs in work zones, Journal of the Transportation Research Board, No 2055, TRB, Washington, D.C., pp. 31-38.
11. R. F. Benekohal, H. Ramezani, K. Avrenli, (2010) Delay and User's Cost in Highway Work Zones, Research Report FHWA-ICT-10-075.
<http://ict.illinois.edu/publications/report%20files/FHWA-ICT-10-075.pdf>.
12. S. Sadeghhosseini, R.F. Benekohal, (2005), Space headway and safety of platooning highway traffic, Traffic Congestion and Traffic Safety in the 21st Century, Chicago, Illinois, pp. 472-478.
13. S.I.J. Chien, D.G. Goulias, S. Yahalom, S.M. Chowdhury, (2002), simulation-based estimates of delays at freeway work zones. Journal of Advanced Transportation, 36 (2), 131-156.
14. X. Jiang, H. Adeli, (2003), Freeway work zone traffic delay and cost optimization model, Journal of Transportation Engineering, ASCE 129 (3), 230-241.
15. Y. Jiang, (1999), A model for estimating excess user costs at highway work zones, Journal of the Transportation Research Board, No 1657, TRB, Washington, D.C., pp. 31-41.

APPENDIX A: STEP-BY-STEP ALGORITHM TO ESTIMATE CAPACITY

The software algorithm is based on the methodology proposed by Benekohal, Ramezani and Avrenli (2010). Given the input data, the algorithm first estimates the work zone capacity under the prevailing geometric and traffic control conditions. The capacity estimation is achieved with respect to the four-regime speed-flow curves suggested by Benekohal, Ramezani and Avrenli (2010). Once the user enters the traffic demand and composition, the program estimates the queue length, delay and users' cost for each interval of analysis.

The step-by-step algorithm consists of the following steps:

- 1.** Find the speed reductions due to less-than-ideal lane width (R_{LW}) and lateral clearance (R_{LC}) from Table A-1.

Table A-1: Adjustment due to lane width and lateral clearance

Adjustment for lane width				
Lane width (ft)	Reduction in speed (mph)			
12 ft or more	0.0			
11	1.9			
10	6.6			
9	15.0			
8	25.0			
Adjustment for left shoulder				
Left shoulder (ft) width	Reduction in speed (mph)			
2 ft or more	0			
1	1			
0	2			
Adjustment for right shoulder				
Right shoulder width (ft)	Reduction in speed (mph)			
	No of Lanes in one direction (without work zone)			
	2	3	4	>= 5
6 ft or more	0	0.0	0.0	0.0
5	0.6	0.4	0.2	0.1
4	1.2	0.8	0.4	0.2
3	1.8	1.2	0.6	0.3
2	2.4	1.6	0.8	0.4
1	3.6	2.0	1.0	0.5
0	3.9	2.4	1.2	0.6

*: Based on the authors' best estimate

2. Determine the level of work intensity for short-term work zones by Table A-2 and for long-term work zones by Table A-3.

Table A-2. Work intensity table for short-term work zones

		(# of workers) + (# of large construction equipment) in the work activity area														
		1	2	3	4	5	6	7	8	9	10	11	12	13	14	15
Lateral distance between the work activity area and the edge of the open lane (ft)	9	LO	LO	LO	LO	LO	LO	M	M	M	M	M	M	M	M	M
	8	LO	LO	LO	LO	LO	O	M	M	M	M	M	M	M	M	M
	7	LO	LO	LO	LO	O	M	M	M	M	M	M	M	M	M	M
	6	LO	LO	LO	LO	O	O	M	M	M	M	M	M	M	M	M
	5	LO	LO	LO	O	O	O	O	M	M	M	M	M	M	HI	HI
	4	LO	LO	O	O	O	O	O	O	O	O	HI	HI	HI	HI	HI
	3	LO	LO	O	O	O	O	O	HI	HI	HI	HI	HI	HI	HI	HI
	2	LO	O	O	O	O	HI	HI	HI	HI	HI	HI	HI	HI	HI	HI
	1	O	O	HI	HI	HI	HI	HI	HI	HI	HI	HI	HI	HI	HI	HI

LO=Low work intensity MO=Moderate work intensity HI=High work intensity

Table A-3. Work intensity table for long-term work zones

		(# of workers) + (# of large construction equipment) in the work activity area															
		1	2	3	4	5	6	7	8	9	10	11	12	13	14	15	
Lateral distance between the work activity area and the edge of the concrete barrier closer to the activity area (ft)	9	LO	LO	LO	LO	LO	LO	LO	LO	MO	MO	MO	MO	MO	MO	MO	
	8	LO	LO	LO	LO	LO	LO	LO	LO	MO	MO	MO	MO	MO	MO	MO	
	7	LO	LO	LO	LO	LO	LO	LO	MO	MO	MO	MO	MO	MO	MO	MO	
	6	LO	LO	LO	LO	LO	LO	MO	MO	MO	MO	MO	MO	MO	MO	MO	
	5	LO	LO	LO	LO	LO	MO	MO	MO	MO	MO	MO	MO	MO	MO	MO	
	4	LO	LO	LO	MO	MO	MO	MO	MO	MO	MO	MO	MO	MO	HI	HI	HI
	3	LO	LO	MO	MO	MO	MO	MO	MO	MO	MO	HI	HI	HI	HI	HI	HI
	2	LO	MO	MO	MO	MO	MO	MO	HI	HI	HI	HI	HI	HI	HI	HI	HI
	1	MO	MO	MO	HI	HI	HI	HI	HI	HI	HI	HI	HI	HI	HI	HI	HI

LO=Low work intensity MO=Moderate work intensity HI=High work intensity

3. Find the speed reduction corresponding to the work intensity determined in step 2. Use

Table A-4 for short-term work zones and Table A-5 for long-term work zones.

Table A-4. Speed reduction due to work intensity in short term work zones

Work Intensity	Estimated Speed Reduction Range (mph)	Suggested Speed Reduction (mph)
LOW	6.04 - 10.80	8.00
MODERATE	10.81 - 14.40	12.00
HIGH	14.41 - 19.16	16.00

Table A-5. Speed reduction due to work intensity in long-term work zones

Work Intensity	Estimated Speed Reduction Range (mph)	Suggested Speed Reduction (mph)
LOW	0.01 - 2.65	2
MODERATE	2.66 - 3.80	3
HIGH	3.81 - 5.93	5

4. Find the speed reduction (mph) due to any treatment by using Table A-6.

Table A-6. Speed reduction reported in the literature

Speed Control Technique	Observed Range of Speed Reduction (mph)	Typical Speed Reduction (mph)
Changeable Message Signs ¹	1.4 - 4.7	3.0
Drone Radar ²	1.2 - 9.8	2.5
Police Presence ³	4.3 - 5.0	4.5
Speed Photo Enforcement ³	3.4 - 7.8	5.0
MUTCD Flagging ⁴	3.0 - 12.0*	7.0*
Innovative Flagging ^{4,**}	4.0 - 16.0*	10.0*
Changeable Message Signs with Radar ⁵	4.0 - 8.0	5.0

Speed Monitoring Display ⁵	4.0 - 5.0	4.0
---------------------------------------	-----------	-----

*: In the case of flagger, the authors recommend the use of the speed-flow curves for a speed limit of 45 mph and flagger in the work zone rather than the suggested speed reduction shown in the table.

** : Innovative flagging is the combination of the flagging procedure described in MUTCD with the flagger using the other hand to motion the traffic to slow, and then to point to an adjacent speed limit sign (Garber and Srinivasan, 1998).

¹: Benekohal et al (1992)

²: Benekohal et al (1993)

³: Benekohal et al (2008)

⁴: Richards et al (1985)

⁵: Mattox et al (2007)

5. Compute the adjusted free flow speed by Equation A-1:

$$AFFS = FFS - R_{WI} - R_{LW} - R_{LC} - R_T - R_o \quad (A-1)$$

where

AFFS= Adjusted free flow speed (mph)

FFS =Free-flow speed (when there are no field data, FFS=62 mph for speed limit of 55 mph, FFS=55 mph for a site with speed limit of 45 mph and without flagger, and FFS=43 mph for a site with speed limit of 45 mph and presence of flagger)

R_{LW} = Speed reduction due to lane width (mph),

R_{LC} =Speed reduction due to lateral clearance (mph),

R_{WI} = Speed reduction due to work intensity (mph),

R_T = Speed reduction due to treatment (mph),

R_o = Speed reduction due to all other factors that may reduce speed (mph) (including those that may cause a flow breakdown).

6. Find the speed-flow curve corresponding to the adjusted free flow speed and read the maximum flow rate (C_{Max}) from the speed-flow curve. Use Figure A-1 for a site with speed limit of 45mph and flagger, Figure A-2 for speed limit of 45 mph without a flagger, Figure A-3 for speed limit of 55 mph and flagger.

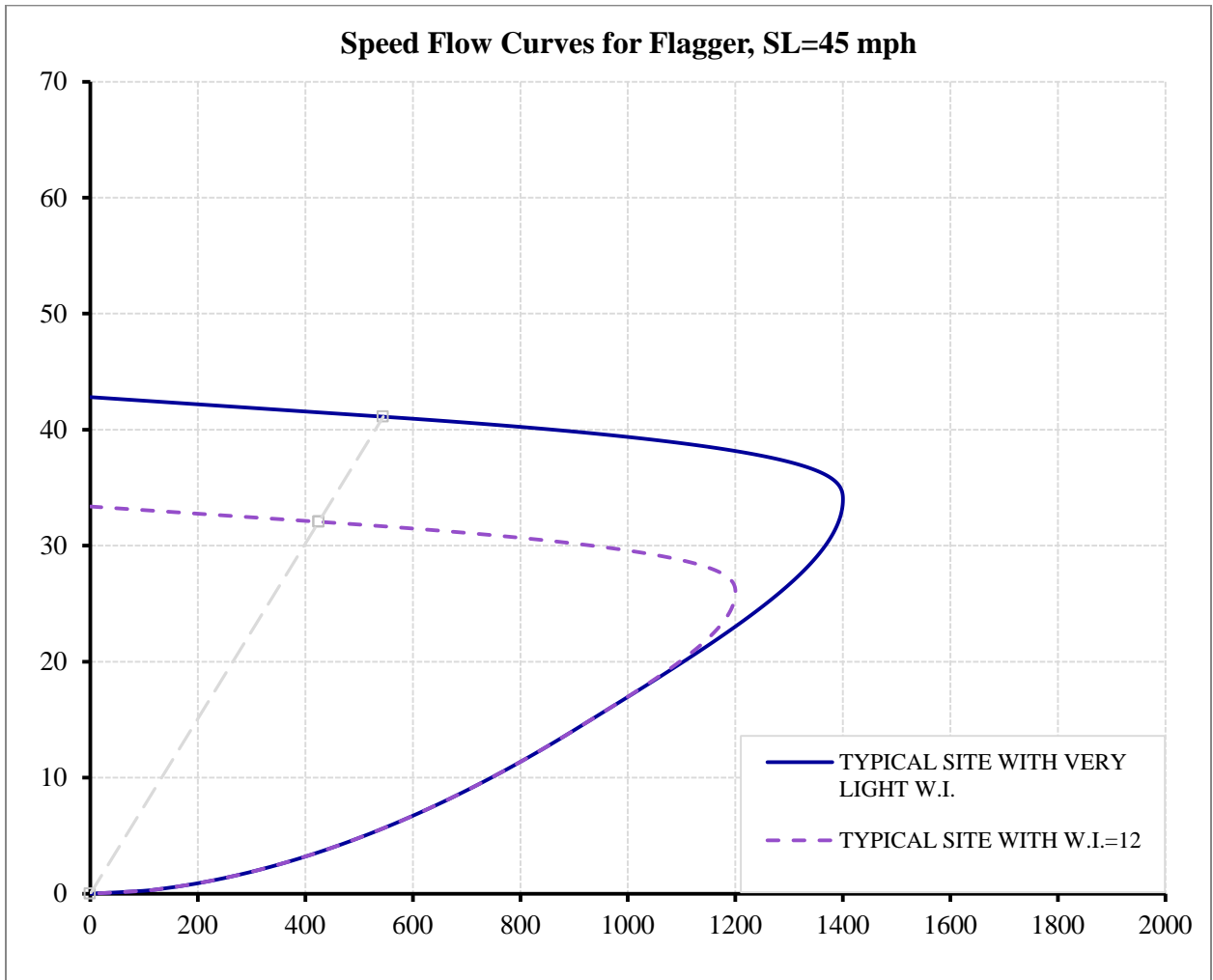

Figure A-1. Speed-Flow Curve For A Site With Speed Limit Of 45 Mph And Flagger

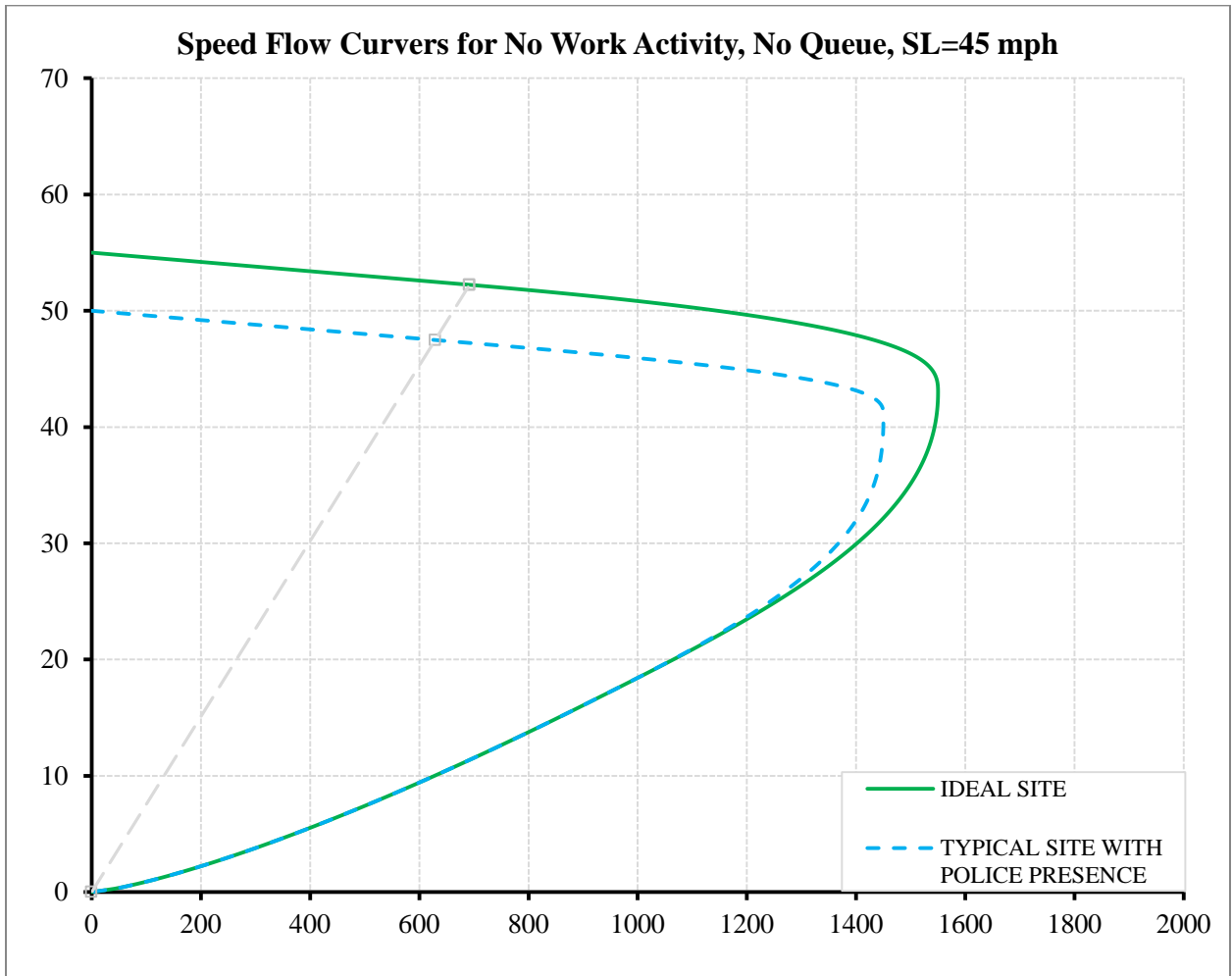

Figure A-2. Speed-Flow Curve For A Site With Speed Limit Of 45 Mph And No Flagger

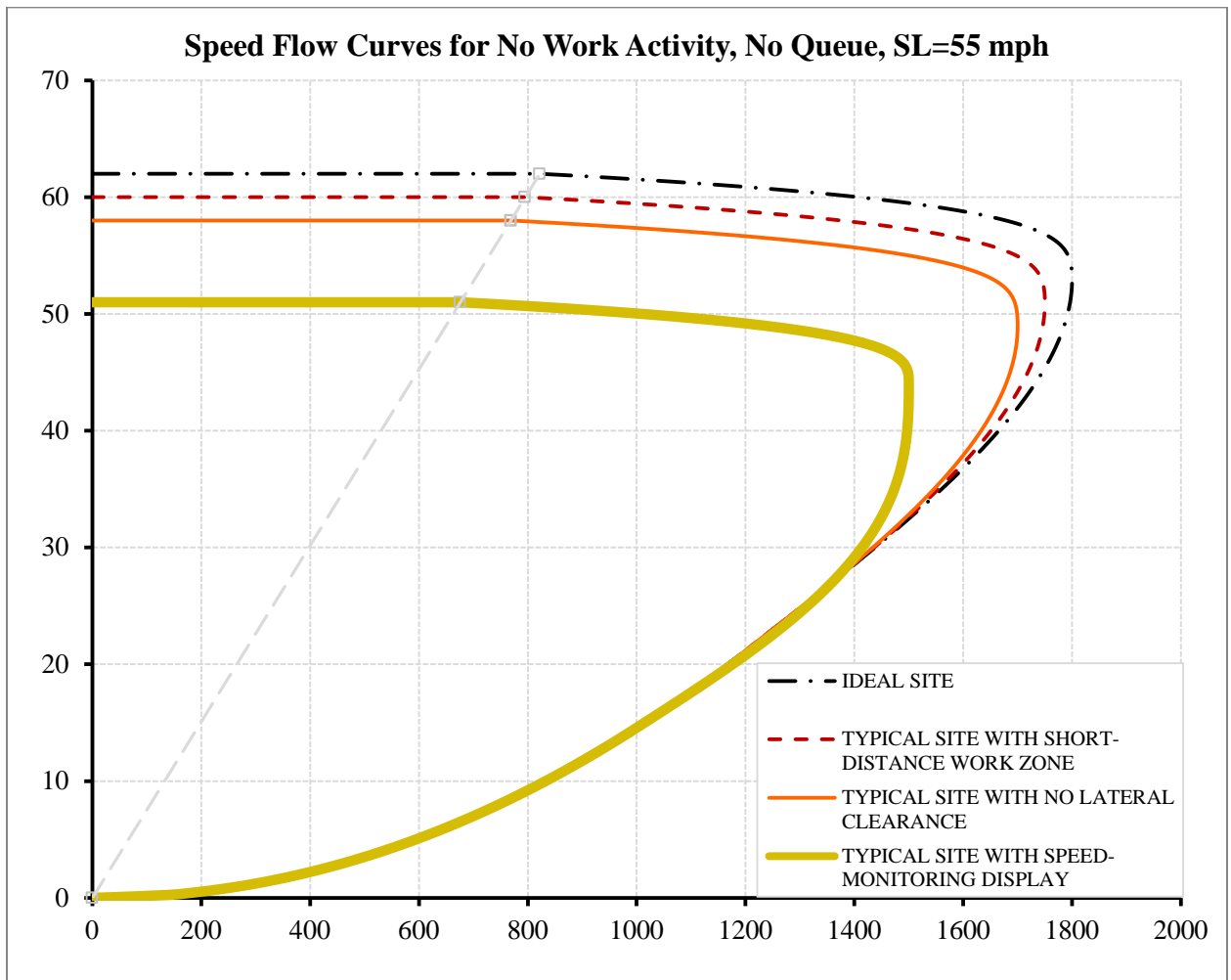

Figure A-3. Speed –Flow Curve For A Site With Speed Limit Of 55 Mph

7. Step 7 is skipped

8. Compute heavy vehicle adjustment factor as below:

$$f_{HV} = \frac{1}{1 + P_T(PCE - 1)} \quad (A-2)$$

where

f_{HV} = Heavy vehicle adjustment factor

P_T = Total percentage of trucks. (Entered as decimal)

PCE = Passenger car equivalence factor determined by using Table A-7 when no grade is long enough or steep enough to cause a significant speed reduction on trucks (when no

one grade of 3% or greater is longer than 0.25 mile or where no one grade of less than 3% is longer than 0.5 mile). Otherwise, PCE should be obtained from the Highway Capacity Manual 2010.

Table A-7. Passenger Car Equivalents

Passenger Car Equivalence	Type of Terrain		
	Level	Rolling	Mountainous
Trucks and Buses	1.5	2.5	4.5

9. Calculate the adjusted capacity:

$$C_{adj} = \text{Capacity} * f_{HV} \quad (A-3)$$

where

C_{adj} = Adjusted capacity (vphpl),

Capacity = Capacity corresponding to the traffic condition in the work zone (pcphpl),

f_{HV} = Heavy vehicle adjustment factor.